

## BM-18

### MULTITASK PLATE AND PIPE BEVELLER



#### THE BM-18 IS A NEW GENERATION PORTABLE MULTITASK PLATE AND PIPE BEVELLER DRIVEN BY A POWERFUL ELECTRIC MOTOR.

It enables milling straight edges up to 18 mm bevel width, contours, holes from 40 mm in diameter and rounding off steel construction before painting or coating with radius R2, R3, R4 or R5.

New hexagonal fixing of milling heads increases beveller durability and makes replacement of the heads more convenient and user-friendly. Variable spindle speed enables optimizing cutting conditions depending on sort of material grade incl. stainless steel, alloys, aluminum, brass or plastic.

#### FEATURES & BENEFITS:

- ✓ Powerful electric motor.
- ✓ Maximum 18 mm bevel width (more than one pass could be required).
- ✓ Continuous bevel width adjustment.
- ✓ New more durable milling heads with hexagonal fixing for easy replacement.
- ✓ Electronic speed control between 1800–5850 rpm for use on a variety of materials.
- ✓ Overload protection.
- ✓ Beveling milling head is equipped with 5 pcs of 2-sided indexable cutting inserts.
- ✓ Milling head for rounding is equipped with 4 pcs of 4-sided indexable inserts up to R5.

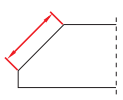

Max bevel  
width 18 mm

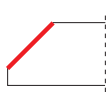

Top beveling

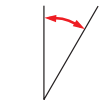

Bevel angles  
22.5°, 30°, 37.5°,  
45°, 50°, 55°, 60°



Countersinking  
Min. ID 40 mm

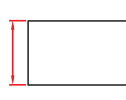

Min plate  
thickness  
2 mm

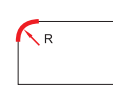

Rounding edges  
(option)  
R2, R3, R4 or R5

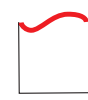

Arched edge  
beveling



Pipe ID beveling  
Min. ID 40 mm



Pipe OD  
beveling

CALL 01706 229 490 TO BOOK YOUR DEMONSTRATION NOW OR VISIT [WWW.STEELBEAST.CO.UK](http://WWW.STEELBEAST.CO.UK)

## NEW DESIGN OF MILLING HEADS WITH HEXAGONAL FIXING

- ✓ Increases durability.
- ✓ More convenient assembly and disassembly of the milling head.
- ✓ Guiding roller is integrated with each milling head.
- ✓ The clearance between milling head and guiding roller is precisely factory calibrated, thus requires no adjustment by the operator.



Accessories:	
BM18CMH22.5	Beveling milling head 22.5° (5 cutting inserts required)
BM18CMH30	Beveling milling head 30° (5 cutting inserts required)
BM18CMH37.5	Beveling milling head 37.5° (5 cutting inserts required)
BM18CMH45	Beveling milling head 45° (5 cutting inserts required)
BM18CMH50	Beveling milling head 50° (5 cutting inserts required)
BM18CMH55	Beveling milling head 55° (5 cutting inserts required)
BM18CMH60	Beveling milling head 60° (5 cutting inserts required)
BM161S	Cutting insert for steel
BM161A	Cutting insert for aluminum
BM17RMH	Milling head for rounding (4 cutting inserts required)
BM161R2	Cutting insert R2
BM161R3	Cutting insert R3
BM161R4	Cutting insert R4
BM161R5	Cutting insert R5

Spare and consumable parts:	
BM16RMHS	Insert Screw (Radius)
BM16BMHS	Insert Screw (Beveling)
BM16-GR	Screw grease (5 g)
BM16-BR	Beveling roller
BM16-RR	Radius roller
BM16-24.32	Carbon brush
BM16-ASG	Sticker against scratches (for aluminum beveling)

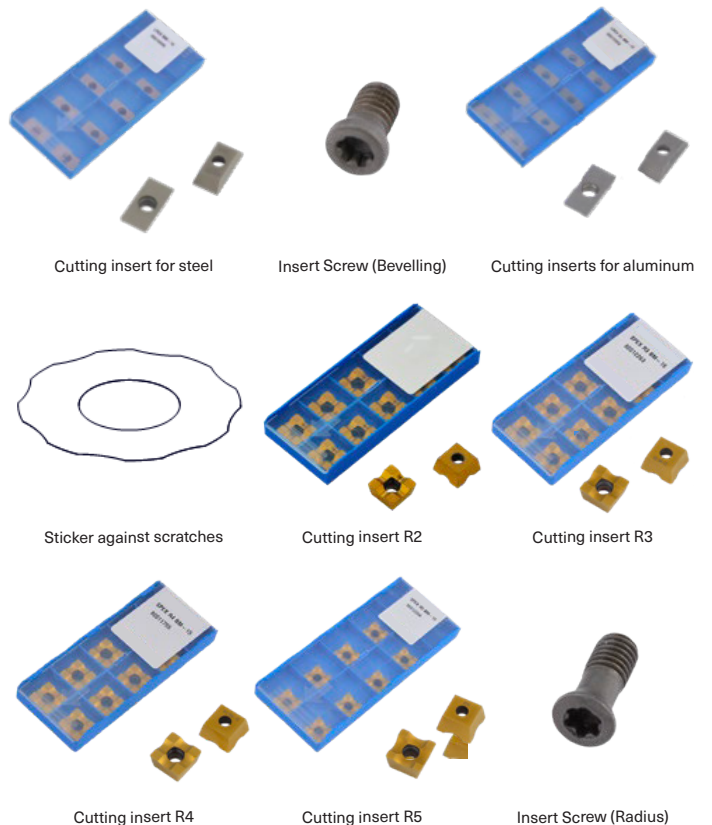

## RADIUS INSERT POSITIONER FOR BM-18

Useful device for easy and precise setting of radius R2, R3, R4 and R5.  
Product code: BM16-RP

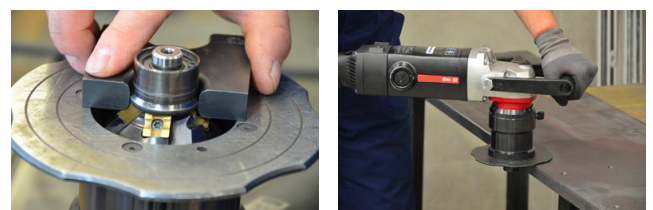

CALL 01706 229 490 TO BOOK YOUR DEMONSTRATION NOW OR VISIT [WWW.STEELBEAST.CO.UK](http://WWW.STEELBEAST.CO.UK)

## PIPE ATTACHMENT FOR BM-18

Allows external beveling of pipes with a diameter of at least 150 mm (5.9") and internal bevelling of pipes with a diameter of at least 110 mm (4.3"). Product code: BM16-PA



## WORKTABLE FIXTURE FOR BM-18

Handy and convenient tool for machining small workpieces with cross section of at least 15x25 mm (0.6x1") and length of at least 400 mm (16"). The width of the workpiece can be up to 100 mm (4"), and height up to 65 mm (2.5"). The maximum bevel width is 14 mm (0.55"). Product Code: BM16-WT



CALL **01706 229 490** TO BOOK YOUR DEMONSTRATION NOW OR VISIT **WWW.STEELBEAST.CO.UK**

BM-18 Technical Specification:	
Power supply	1~ 220-240 V, 50-60 Hz - 1~ 110-120 V, 50-60 Hz
Power	2200 W
Max Bevel (b)	18 mm
Spindle speed w/o load	1800-5850 rpm
Bevel angle (depending on milling head)	$\beta = 22.5^\circ, 30^\circ, 37.5^\circ, 45^\circ, 50^\circ, 55^\circ, 60^\circ$ (Fig. 1)
Minimum workpiece thickness	2 mm (0.08")
Minimal diameter of countersinking	ca 40 mm (1.57")
Rounding edges	R2, R3, R4, R5 (Fig. 2)
Dimensions (L x W x H)	585 mm (23.0") x 156 mm (6.1") x 238 mm (9.4")
Weight (without milling head)	10 kg (22 lbs)
Product code 220-240 V, 50-60 Hz	BM18/2
Product code 110-120 V, 50-60 Hz	BM18/1

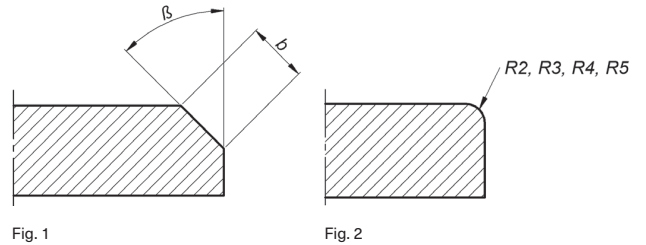

### Basic set:

- ✓ BM-18 beveling machine without accessories.
- ✓ Plastic box.
- ✓ 32mm flat wrench.
- ✓ Allen wrench hex s=6.
- ✓ Grease for screws (5 g, 0.17 oz).
- ✓ Operator's Manual (English).

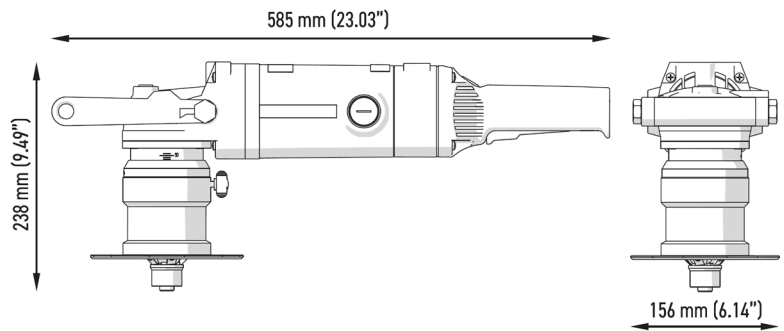

Aluminum beveling



Countersinking



Rounding off curved edges



Pipe beveling

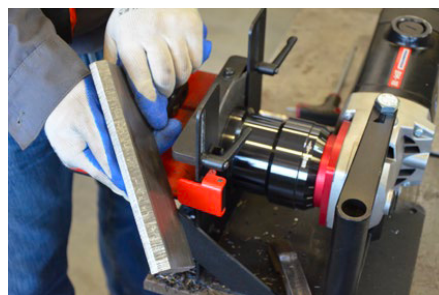

Machining small workpieces



Lightweight and durable plastic box for convenient storage and transportation

CALL **01706 229 490** TO BOOK YOUR DEMONSTRATION NOW OR VISIT [WWW.STEELBEAST.CO.UK](http://WWW.STEELBEAST.CO.UK)