



Barcode: 5060452080871

safestor™

Product code: HMC1

- » Medium duty hazardous storage cupboard.
- » Liquid-tight sump to contain spillages.
- » Designed for storing flammables or chemicals.



Product features



COSHH compliant



Sump capacity



UDL per shelf



Fire resistant



Safety signage



Cam lock



Standard 80mm castors

Product specifications

Weight	26kg
Colour	Traffic yellow: RAL 1023
Suitable for	Indoor storage of flammables or chemicals
Finished coating	Powder coated
Material & thickness	0.9mm steel
Quantity of keys	2 keys
How are castors fitted?	Removable dolly
Other sizes available	8 other sizes
Ventilation	No
Qty of shelves as standard	1 shelf

Dimensions

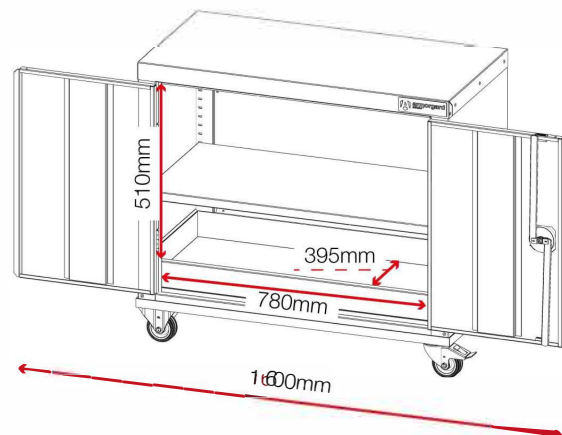
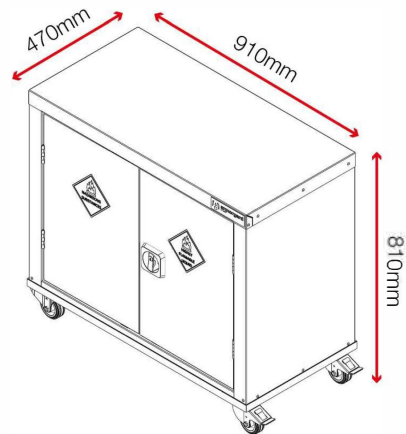

Optional extras



Stand HCS2



SafeStor shelf