



USE AND MAINTENANCE MANUAL

TRANSLATION OF THE ORIGINAL INSTRUCTIONS — ENGLISH

POWER WELDERS

CS 230 YSX CC/CV (STAGE V)

- Motosaldatrice
- Engine Driven Welder
- Motosoudeuse
- Motosoldadoras
- Schweißaggregat
- Motosoldadora
- По Вышкам
- Lassers

Codice
Code
Code
Codigo
Kodezahl
Código
Код
Code

COMP60119003

Edizione
Edition
Édition
Edición
Ausgabe
Edição
Издание
Editie

07.2020



MADE IN ITALY



MOSA Weld

0. GENERAL INFORMATION

M1.1	INTRODUCTION	PAG. 4
M1.4.2	CE MARK.....	PAG. 5
M2	SYMBOLS AND SAFETY PRECAUTIONS	PAG. 6
M2.1	WARNINGS.....	PAG. 7
M2.5...	SAFETY RULES.....	PAG. 8

1. GENERAL INFORMATION OF THE MACHINE

M0	DESCRIPTION OF THE MACHINE	PAG. 12
	RECORDING DATA.....	PAG. 13

2. TRANSPORT AND HANDLING

M3	MACHINE UNPACKING	PAG. 14
M4.1	TRANSPORT AND HANDLING COVERED UNITS.....	PAG. 15

3. INSTALLATION AND USE

M2.7	INSTALLATION.....	PAG. 16
M2.6	INSTALLATION ADVICES.....	PAG. 17
	ELECTROMAGNETIC COMPATIBILITY.....	PAG. 18
M20	SET-UP FOR OPERATION DIESEL ENGINE.....	PAG. 19
	EARTHING.....	PAG. 20
M21	STARTING AND STOPPING DIESEL ENGINE.....	PAG. 21
M30	CONTROLS LEGENDE.....	PAG. 22
M31	CONTROLS.....	PAG. 23
M32	COMPONENTS OF FRONT PANEL.....	PAG. 24
M33...	WAC (WELDING ANALOG CONTROL)	PAG. 25
M34	USE AS WELDER.....	PAG. 27
M37...	USE AS GENERATOR.....	PAG. 28

4. INSTRUMENTS USE

M38.10	REMOTE CONTROL.....	PAG. 30
M55	RECOMMENDED ELECTRODES.....	PAG. 31

5. MAINTENANCE

M40.2...	TROUBLE SHOOTING.....	PAG. 32
M43	MAINTENANCE.....	PAG. 35
M45	STORAGE AND DISASSEMBLE	PAG. 36

6. TECHNICAL INFORMATIONS

M1.5	TECHNICAL DATA	PAG. 37
M1.6	TECHNICAL DATA	PAG. 38
M2.7.1...	DIMENSIONS.....	PAG. 39

Dear Customer,

We wish to thank you for having bought a high quality set. Our sections for Technical Service and Spare Parts will work at best to help you if it were necessary.

To this purpose we advise you, for all control and overhaul operations, to turn to the nearest authorized Service Centre, where you will obtain a prompt and specialized intervention.

☞ In case you do not profit on these Services and some arts are replaced, please ask and be sure that are used exclusively original parts; this to guarantee that the performances and the initial safety prescribed by the norms in force are re-established.

☞ *The use of **non original spare parts will cancel immediately any guarantee and Technical Service obligation.***

NOTES ABOUT THE MANUAL

Before actioning the machine please read this manual attentively. Follow the instructions contained in it, in this way you will avoid inconveniences due to negligence, mistakes or incorrect maintenance. The manual is for qualified personnel, who knows the rules: about safety and health, installation and use of sets movable as well as fixed.

You must remember that, in case you have difficulties for use or installation or others, our Technical Service is always at your disposal for explanations or interventions.

The manual for Use Maintenance and Spare Parts is an integral part of the product. It must be kept with care during all the life of the product.

In case the machine and/or the set should be yielded to another user, this manual must also given to him.

Do not damage it, do not take parts away, do not tear pages and keep it in places protected from dampness and heat.

You must take into account that some figures contained in it want only to identify the described parts and therefore might not correspond to the machine in your possession.

INFORMATION OF GENERAL TYPE

In the envelope given together with the machine and/or set you will find: the manual for Use Maintenance and Spare Parts, the manual for use of the engine and the tools (if included in the equipment), the guarantee (in the countries where it is prescribed by law).

The Manufacturer shall not be liable for ANY USE OF THE PRODUCT OTHER THAN THAT PRECISELY SPECIFIED IN THIS MANUAL and is thus not liable for any risks which may occur as a result of IMPROPER USE. The Company does not assume any liability for any damage to persons, animals or property.

Our products are made in conformity with the safety norms in force, for which it is advisable to use all these devices or information so that the use does not bring damage to persons or things.

While working it is advisable to keep to the personal safety norms in force in the countries to which the product is destined (clothing, work tools, etc.).

Do not modify for any motive parts of the machine (fastenings, holes, electric or mechanical devices, others..) if not duly authorized in writing: the responsibility coming from any potential intervention will fall on the executioner as in fact he becomes maker of the machine.

☞ **NOTICE:** *the manufacturer, who keeps the faculty, apart the essential characteristics of the model here described and illustrated, to bring betterments and modifications to parts and accessories, without putting this manual uptodate immediately.*



Any of our product is labelled with CE marking attesting its conformity to applicable directives and also the fulfillment of safety requirements of the product itself; the list of these directives is part of the declaration of conformity included in any machine standard equipment.

Here below the adopted symbol:



CE marking is clearly readable and unerasable and it can be either part of the data-plate.

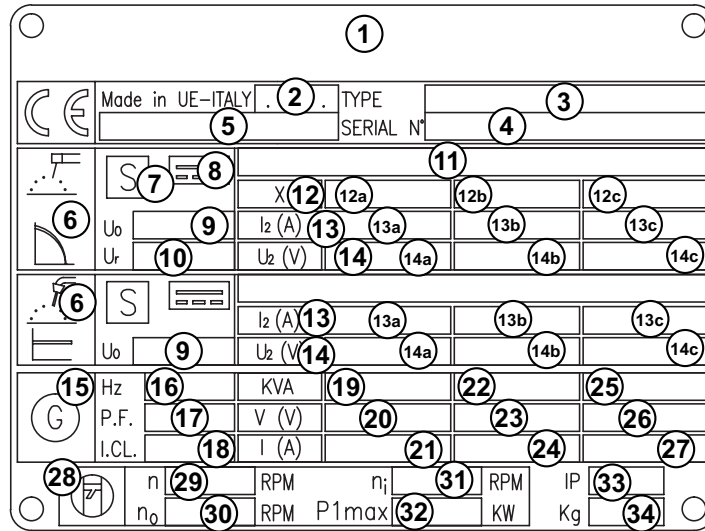

- | | | |
|---|---|--------------------------|
| 1. Manufacturer name or brand | 11. Maximum and minimum welding current values and relative voltage value | 18. Insulation class |
| 2. Year of production | 12. Duty cycle symbol | 19. Rated power (kVA/kW) |
| 3. Engine Driven Welder model | 12a. Duty cycle values | 20. Rated voltage (V) |
| 4. Serial number registration number | 12b. Duty cycle values | 21. Rated current (A) |
| 5. Reference to the standard confirming that the Engine Driven Welder complies with its requirements | 12c. Duty cycle values | 22. Rated power (kVA/kW) |
| 6. Welding process symbol | 13. Rated welding current symbol | 23. Rated voltage (V) |
| 7. Symbol for Engine Driven Welders which can be used an environment with increased risk of electric shock. | 13a. Rated welding current values | 24. Rated current (A) |
| 8. Welding current symbol | 13b. Rated welding current values | 25. Rated power (kVA/kW) |
| 9. OCV value (Rated no-load voltage) or adjustment range between minimum and maximum value | 13c. Rated welding current values | 26. Rated voltage (V) |
| 10. Reduced rated no-load voltage in case of a voltage reducing device (VRD) | 14. Conventional load voltage symbol | 27. Rated current (A) |
| | 14a. Welding voltage values | 28. Engine symbol |
| | 14b. Welding voltage values | 29. Rated speed |
| | 14c. Welding voltage values | 30. Rated no-load speed |
| | 15. Auxiliary power supply symbol | 31. Rated idle speed |
| | 16. Rated frequency | 32. Engine maximum power |
| | 17. Power factor $\cos\phi_p$ | 33. IP degree protection |
| | | 34. Dry weight (kg) |

Furthermore, on each model it is shown the noise level value; the symbol used is the following:

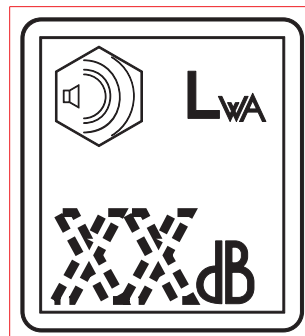



The indication is shown in a clear, readable and indeleble way on a sticker.

SYMBOLS IN THIS MANUAL

- The symbols used in this manual are designed to call your attention to important aspects of the operation of the machine as well as potential hazards and dangers for persons and things.
Moreover, this symbolism intends to draw your attention with the aim to give you indications for a correct use and, as a result, to obtain a good operation of the machine or equipment used.

SAFETY PRECAUTIONS

 **DANGEROUS**
This heading warns of an immediate danger for persons as well for things. Not following the advice can result in serious injury or death.

 **WARNING**
This heading warns of situations which could result in injury for persons or damage to things.

 **CAUTION**
To this advice can appear a danger for persons as well as for things, for which can appear situations bringing material damage to things.

 **IMPORTANT**

 **NOTE**

 **ATTENTION**
These headings refer to information which will assist you in the correct use of the machine and/or accessories.

SIMBOLS



STOP - Read absolutely and be duly attentive



Read and pay due attention



DANGER



GENERAL ADVICE - If the advice is not respected damage can happen to persons or things.



HIGH VOLTAGE - Attention High Voltage. There can be parts in voltage, dangerous to touch. The non observance of the advice implies life danger.



FIRE - Danger of flame or fire. If the advice is not respected fires can happen.



HEAT - Hot surfaces. If the advice is not respected burns or damage to things can be caused.



EXPLOSION - Explosive material or danger of explosion. in general. If the advice is not respected there can be explosions.



ACIDS - Danger of corrosion. If the advice is not respected the acids can cause corrosions with damage to persons or things.



PRESSION - Danger of burns caused by the expulsion of hot liquids under pressure.

PROHIBITIONS

It is prohibited to smoke while filling the tank with fuel.



The cigarette can cause fire or explosion. If the advice is not respected fires or explosions can be caused.

It is prohibited to use water to quench fires on the electric machine



If the advice is not respected fires or damage to persons can be caused.

Use only with non inserted voltage -



It is prohibited to make interventions before having disinserted the voltage.



ACCES FORBIDDEN to non authorized people.

ADVICE

Use only with safety clothing -



It is compulsory to use the personal protection means given in equipment.



WRENCH - Use of the tools. If the advice is not respected damage can be caused to things and even to persons.



FIRST AID. In case the operator should be sprayed by accident, from corrosive liquids a/o hot toxic gas or whatever event which may cause serious injuries or death, predispose the first aid in accordance with the ruling labour accident standards or of local instructions.

Skin contact	Wash with water and soap
Eyes contact	Irrigate with plenty of water, if the irritation persists contact a specialist
Ingestion	Do not induce vomit as to avoid the intake of vomit into the lungs, send for a doctor
Suction of liquids from lungs	If you suppose that vomit has entered the lungs (as in case of spontaneous vomit) take the subject to the hospital with the utmost urgency
Inhalation	In case of exposure to high concentration of vapours take immediately to a non polluted zone the person involved



FIRE PREVENTION. In case the working zone, for whatsoever cause goes on fire with flames liable to cause severe wounds or death, follow the first aid as described by the ruling norms or local ones.

EXTINCTION MEANS	
Appropriated	Carbonate anhydride (or carbon dioxide) powder, foam, nebulized water
Not to be used	Avoid the use of water jets
Other indications	Cover eventual shedding not on fire with foam or sand, use water jets to cool off the surfaces close to the fire
Particular protection	Wear an autorespiratory mask when heavy smoke is present
Useful warnings	Avoid, by appropriate means to have oil sprays over metallic hot surfaces or over electric contacts (switches, plugs, etc.). In case of oil sprinkling from pressure circuits, keep in mind that the inflamability point is very low.

GENERAL SAFETY INSTRUCTIONS

NOTE: the information contained in this manual are subject to change without notice.

The instructions in this manual are intended as indicative only. It is the responsibility of the owner/operator to evaluate risks and potential damages in relation to the use of the product in the specific conditions of application. Remember that the non observance of the indications of this manual may result in damage to people or things.

In all cases, however, it is understood that the use shall be in compliance with the applicable laws/regulations.

- Before operating the machine, read carefully the safety instructions contained in this manual and other manuals supplied (engine, alternator, etc.).
- All operations, handling, installation, use, maintenance, repair should be carried out by authorized and qualified personnel.
- When operating, wear personal protective equipment (PPE): footwear, gloves, helmet, etc..
- The owner is responsible for maintaining the equipment in safe conditions.

Use only in perfect technical conditions

The machinery or equipment must be used in perfect technical condition. Remove immediately any defects that may affect the safe conditions of use.

- Before starting to use this equipment it is important to take knowledge of all the controls of the machine, all its functions and its correct installation in order to avoid accidents to people and damage to the machine itself. In particular, it is important to know how to stop the equipment quickly in case of emergency.
- Do not allow the use of the machine to people unless previously instructed with all the information for a proper, safe use.
- Forbid the access in the operational area to non authorized personnel, children and pets so as to protect them from possible injury caused by any part of the machine.

SAFETY PRECAUTIONS DURING HANDLING AND TRANSPORTATION

- Lift the machine using only the points allocated for this function.
The lifting eye (or eyes) and the correct positioning of the forks of the forklift are marked with specific adhesives.
- Clear the operational area of possible obstacles and all unnecessary personnel.
- Always use lifting equipment properly sized and controlled by enabled bodies.
- It is forbidden to set on the frame of the equipment objects or accessories that alter weight and center of gravity and cause stresses not foreseen to the lifting points.
- Do not submit the machine and the lifting equipment to swinging or shock which may transmit dynamic stress to the structure.

Equipments with trailers or site tows

- Never drag the machine without trailer (or site tow)
- Check for a correct assembly of the machine to the towing device.
- Always make sure that the hook of the vehicle is suitable for towing of the total mass of the trailer.
- Do not tow the trailer if the coupling devices are worn or damaged.
- Check for proper tire pressure.

- Do not replace the tires with types different from the original ones.
- Check that the brakes and the optical signaling of the trailer are working properly.
- Verify that the bolts of the wheels are in place and well tightened.
- Do not park the machine (on trailer or site tow) on a steep slope.
For the stops, not followed by a work session, always engage the parking brake and / or block the wheels by means of wheel chocks.
- Do not tow the trailer on bumpy roads.
- Do not exceed the maximum permissible speed on public roads of 80 km/h with the trailer, in any case comply with the legislation applicable in the country of use.
- Do not use the site tow on public roads, this is intended for use only in private and delimited areas. The maximum permitted speed is 40 km/h on smooth surfaces (asphalt or concrete), adapt in each case the speed to the type of ground.

SAFETY PRECAUTIONS DURING INSTALLATION AND USE



Do not instal equipments closed to heat source, to explosion or fire risk area.

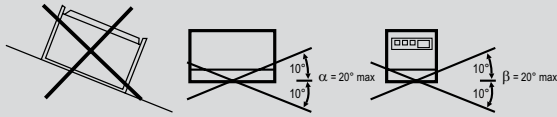

Always locate the machine on a flat and solid ground, so as to avoid tipping, slipping or falling during operation. Avoid using the machine on slopes greater than 10 degrees.

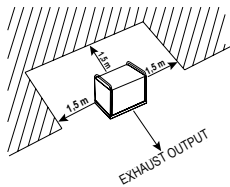

Make sure the area immediately surrounding the machine is clean and free from debris



Do not place objects or obstructions in the vicinity of the air intakes and air outlets, a possible overheating of the generator could cause a fire.



Connect the machine to an earthing system according to the regulations in force at the place of installation. Use the ground terminal on the front of the machine.

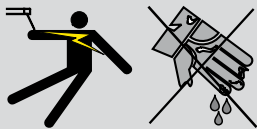

Do not use the machine with wet or damp hands and / or clothing. Use plugs suitable for the output sockets of the machine and make sure that electrical cords are in good condition.

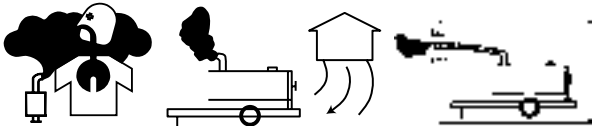

The machine must always be positioned so that the exhaust gases are dispersed in the air without being inhaled by people or living beings. If you use the machine indoors is necessary that the installation is designed and built by skilled technicians in a workmanlike manner.

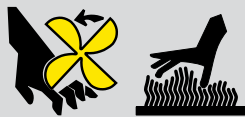











During normal operation, keep doors closed. The access to the internal parts should be allowed only for maintenance reasons.













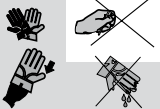

Keep area near to the muffler free from objects such as rags, paper, cardboard. The high temperature of the muffler could cause the burning of objects and cause fire



Immediately stop the machine in case of malfunction. Do not restart the machine without first having found and fixed the problem.

SAFETY PRECAUTIONS DURING MAINTENANCE	
Make use of qualified personnel to carry out maintenance and troubleshooting	
	It is mandatory to stop the engine before performing any maintenance on the machine.
	Always use protective devices and suitable equipment.
	Do not touch the engine, the exhaust pipes and the muffler during operation or immediately after. Allow the engine to cool before performing any operation
	With the machine running pay attention to moving parts such as fans, belts, pulleys. Do not remove the protections and the safety devices unless absolutely necessary, restore them after completion of the maintenance or repair.
	Do not refuel while the engine is running or hot. Do not smoke or use naked flames when refueling.
	Refuel only outdoors or in well ventilated areas. Avoid spilling fuel, especially on the engine. Clean and dry any leaks before restarting the machine
	Slowly unscrew the cap of the fuel tank and put it back always after refueling. Do not fill the tank completely to allow for expansion of the fuel inside
	Do not remove the radiator cap when the engine is running or still hot, the coolant may spurt out and cause serious burns
	Do not handle the battery without the use of protective gloves, the battery fluid contains sulfuric acid, which is very corrosive and dangerous
	Do not smoke, avoid any naked flames or sparks near the battery, the vapors exhaled could cause the battery to explode

ADDITIONAL REQUIREMENTS FOR ENGINE DRIVEN WELDERS

	<p>Do not touch parts with OCV, it can cause mortal shock or heavy burn. OCV is active at welding stick and auxiliary side when welding generating set is working.</p>
	<p>Do not manage electric devices and welding stick with feet, hands or wet dresses.</p>
	<p>Protect yourself from electric shock by insulating yourself from work and ground. Use non-flammable, dry insulating material if possible, or use dry rubber mats, dry wood or plywood, or other dry insulating material.</p>
	<p>Magnetic fields can affect pace-makers. Pace-maker wearers keep away from arc welding and cutting operations and equipment. Wearers should consult their doctor before going near arc welding, gouging, arc cutting, or spot welding operations.</p>
	<p>Breathing welding fumes can be hazardous to your health. Keep your out of the fumes</p>
	<p>Use enough ventilation, exhaust at the arc, or both, to keep fumes and gases from your breathing zone and the general area. If adequacy of ventilation or exhaust is uncertain, have the air quality checked.</p>
	<p>Arc rays can burn eyes and skin. Use welding helmet with correct shade of filter.</p>
	<p>While working protect your eyes using glasses with lateral screen and your head with dedicated cap; in case of restricted working area or unsafe working position also protect your ears.</p>
	<p>Wear complete body protection. Wear oil free protective clothing such as leather gloves, heavy shirt, cuffless pants, and high boots.</p>
	<p>Welding can cause fire or explosion. Have a fire extinguisher nearby, and have a trained fire watcher ready to use it.</p>
	<p>Do not weld near flammable material. Move flammables at least (10 m) away or protect them with flame-proof covers.</p>
	<p>Do not weld containers, structures, etc. with flammable materials inside (tank, cylinder, etc.); in case you need to weld, verify such items by qualified person in order to fully safely operate.</p>
	<p>Hot parts can cause severe burns. Don't touch the welder with bare hand. If handling is needed, use proper tools and/or wear heavy, insulated welding gloves to prevent burns. Allow cooling period before handling parts or working on gun or torch.</p>

The engine driven welder is a unit which ensures the function as:

- a) a current source for arc welding
- b) a current source for the auxiliary generation.

The models YSX are super silenced engine driven welder. The machine construction incorporates an integral roll bar, central lifting point, forklift pockets; a rear canopy provides full access to the engine for maintenance and assures a low noise level. A front canopy can be removed in order to make an easy maintenance possible. It can be used simultaneously as a welder or as a three-phase and single-phase electrical generator.

It is also possible to select welding output in CC or CV mode:

In CC (constant current) mode, you can choose between a characteristic with adjustable arc force, suitable for electrode welding and TIG welding (scratch start).

The CV (constant voltage) mode is suitable for WIRE WELDING (solid or flux-cored) using the optional Mosa Wire Feed Unit.

The recessed control panel is lockable and houses the sockets and machine controls.

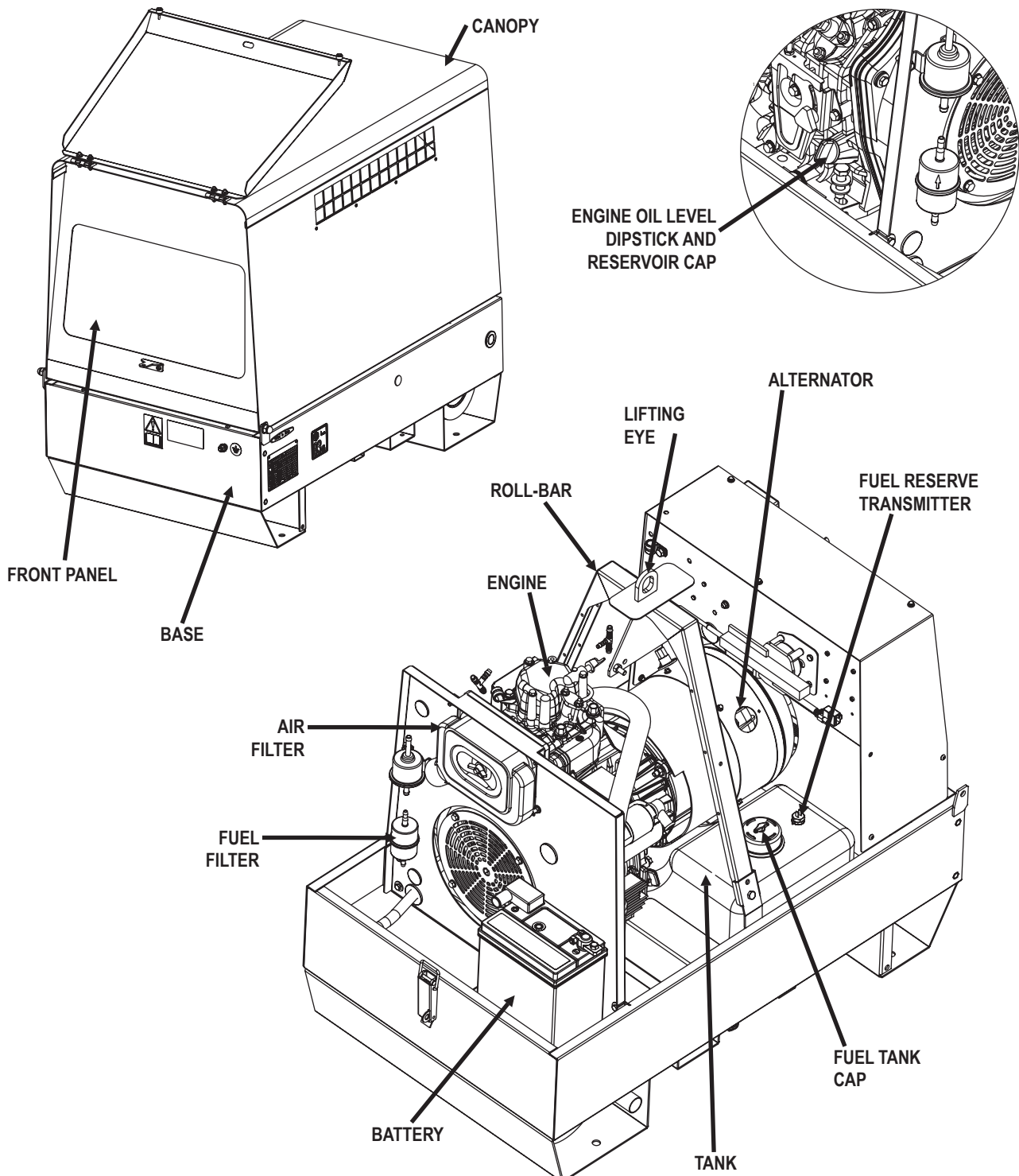

The manual is for the range of machines indicated on the front cover.
With the scope to facilitate the search of the spare parts and maintain information of the bought machine, is necessary to record some data.

Please write the requested data inside the squares to side:

1. Model of machine
2. Serial number of the machine
3. Serial number of the engine
4. Name of the dealer where bought the machine
5. Address of the dealer
6. Phone number of the dealer
7. Date of the bought machine
8. Notes

ENGLISH

ENGLISH

RECORDING DATA

1. _____

2. _____

3. _____

4. _____

5. _____

6. _____

7. _____

8. _____

 **NOTE**

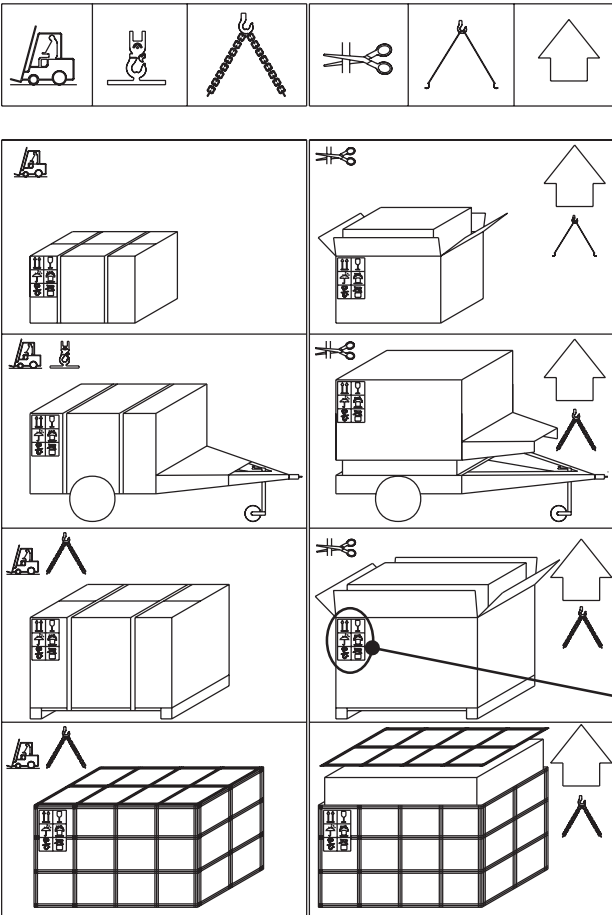

Be sure that the lifting devices are: correctly mounted, adequate for the weight of the machine with its packaging, and conforms to local rules and regulations. When receiving the goods make sure that the product has not suffered damage during the transport, that there has not been rough handling or taking away of parts contained inside the packing or in the set. In case you find damages, rough handling or absence of parts (envelopes, manuals, etc.), we advise you to inform immediately our Technical Service.



For eliminating the packing materials, the User must keep to the norms in force in his country.

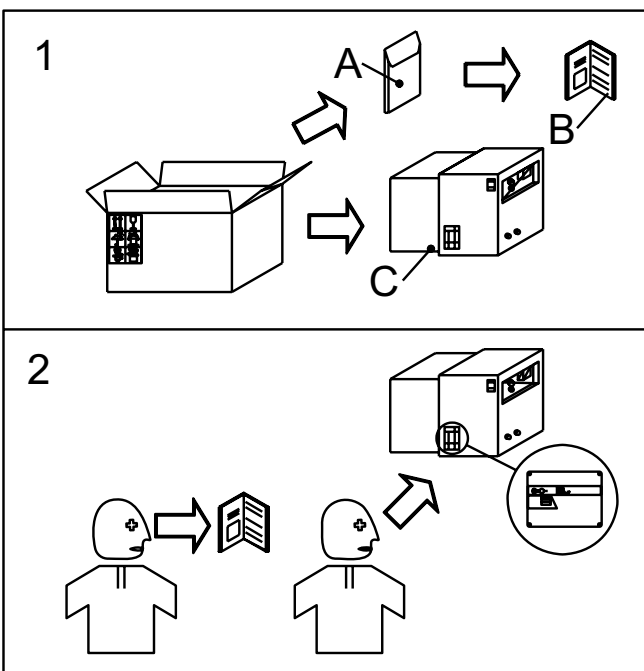
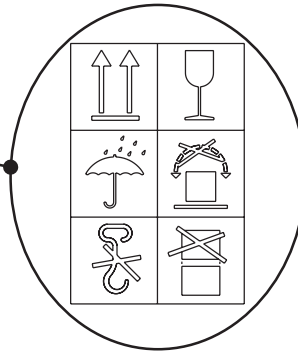

- 1) Take the machine (C) out of the shipment packing. Takeout of the envelope (A) the user's manual (B).
- 2) Read: the user's manual (B), the plates fixed on the machine, the data plate.





NOTE

Transportation must always take place with the engine off, electrical cables and starting battery disconnected and fuel tank empty.

Be sure that the lifting devices are: correctly mounted, adequate for the weight of the machine with it's packaging, and conform to local rules and regulations.

Only authorized persons involved in the transport of the machine should be in the area of movement.

DO NOT LOAD OTHER PARTS WHICH CAN MODIFY WEIGHT AND BARICENTER POSITION.

IT IS STRICTLY FORBIDDEN TO DRAG THE MACHINE MANUALLY OR TOW IT BY ANY VEHICLE (model with no CTL accessory).

If you did not keep to the instructions, you could damage the structure of the machine.

ENGLISH

ENGLISH

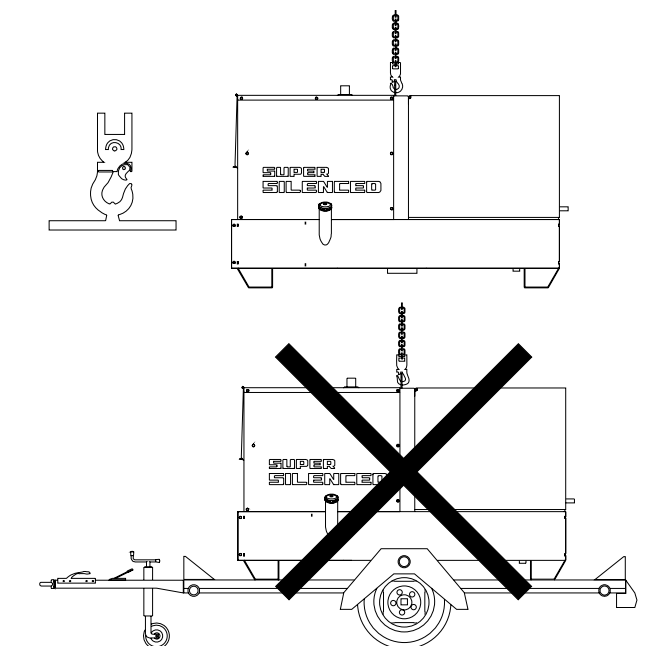
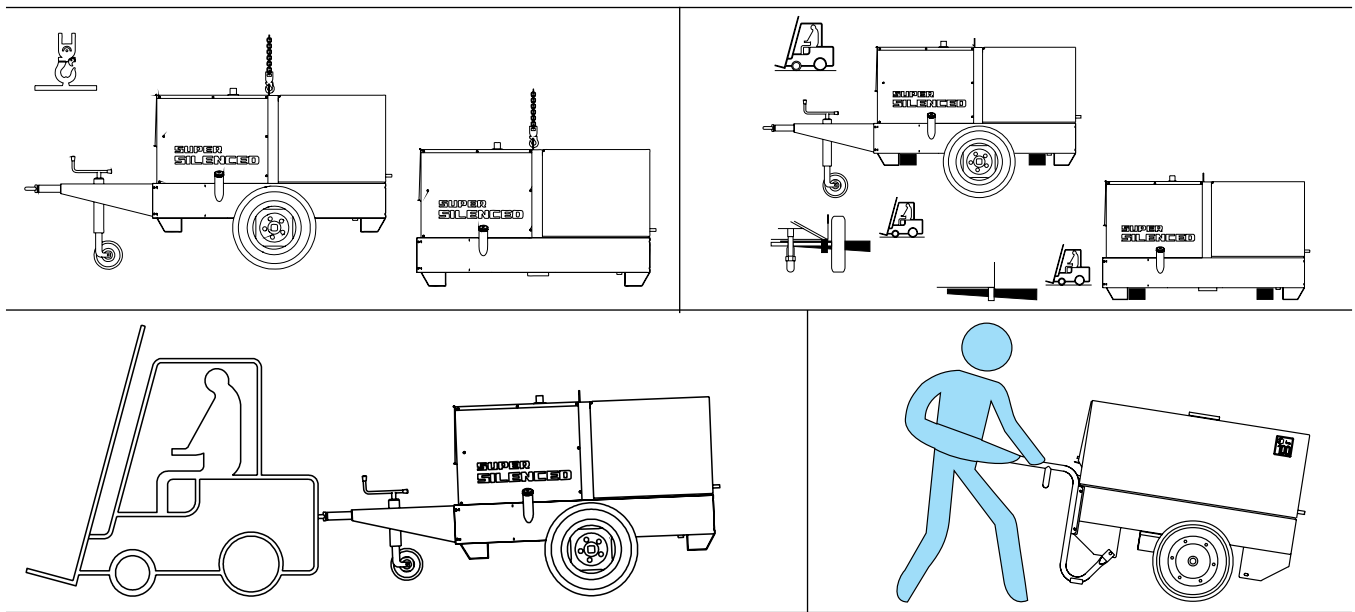

LIFT ONLY THE MACHINE

DO NOT LIFT THE MACHINE AND TRAILER



DANGER: LIFTING EYE IS NOT DESIGNED TO SUPPORT ADDED WEIGHT OF ROAD TOW TRAILER



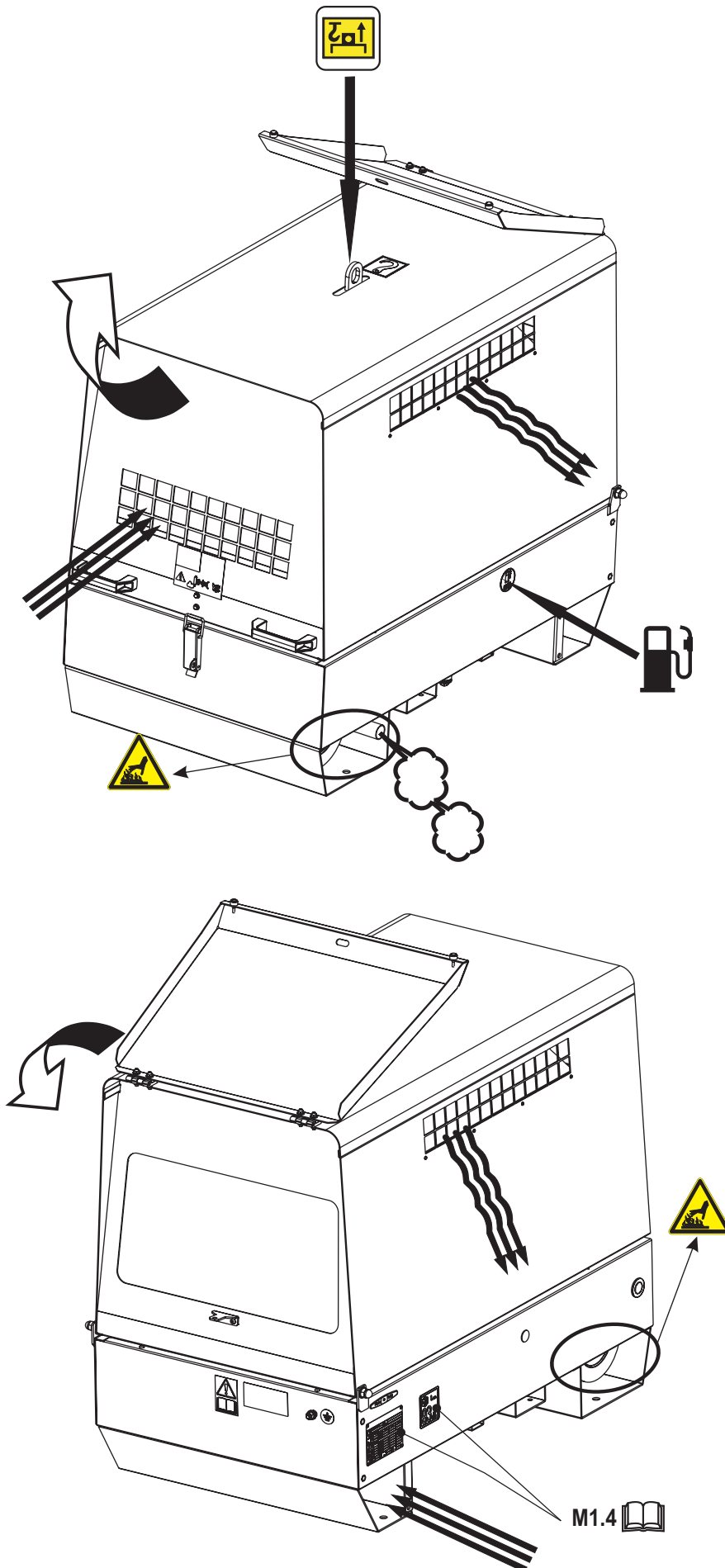

INSTALLATION AND ADVICE BEFORE USE

The operator of the welder is responsible for the security of the people who work with the welder and for those in the vicinity.

Before installing the welder machine, read the safety instruction of this manual at the chapter 2.5.

Particulary remember:

- installing operation must be made by authorized and qualified person.
- while installing operation use individual safety devices (shoes, gloves, cap, etc.)



DANGER



The machine must be positioned so that exhaust gas is diffused without being inhaled by any living being. Engine exhaust gas contains carbon monoxide, which is harmful to one's health, and in big quantities can cause intoxication and death. Local norms in force have to be respected.



ATTENTION



A safe distance has to be kept between the machine and fuel deposits, inflammable goods (cloths, paper, etc.), chemicals, according to indications provided by the authority in charge. In order to avoid potentially dangerous situations, area surrounding genset should be isolated so that unauthorized people will not be able to get close to the unit. Even if The machines are manufactured according to electromagnetic compatibility norms, we suggest NOT to install the genset near machinery that can be influenced by magnetic fields.



ATTENTION



This equipment is designed for outdoor use. It may be stored, but is not intended to be used when welding outside during precipitation unless sheltered

INSTALLATION

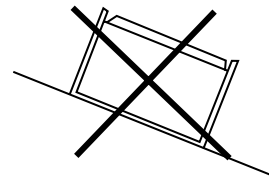

Always instal the welder machine on a hard and plan surface in order to avoid rollovers, slips or falls while working;
avoid to use the welder machine with slope more than 10°.

FIXING

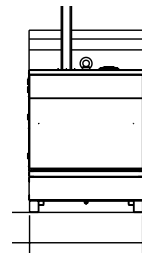

In order to absorb vibrations produced by genset, it should be fixed to a surface with sufficient rigidity, isolated against vibrations towards other structures and with a mass equal to at least three times the genset mass. If such above could not be possible, be sure that the welding machine do not move or slip while working due to vibrations; be care to fix the welder machine with dedicated tools.

MOVING THE WELDER MACHINE

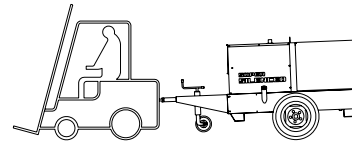

If is needed to move the welder machine be sure that the engine is off, that no electric connection is on and that noone cable will avoid to move the welder machine.

INSTALLATION ON VEHICLE

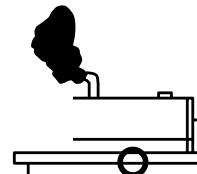

The wrong loads distribution can cause the instability of the vehicle and abnormalities to wheel and components. In case of transport need, use dedicated vehicle for this purpose. The loads must be balanced, fixed in order to guaranty the stability of the vehicle. Do not exceed the max load suitable of the vehicle with reference to axle, wheels, etc. Fix the base of welder machine at the frame or platform observing the instruction of the vehicle producer



This equipment is built in compliance with standard IEC-EN60974-10.

The equipment should be installed and used in accordance with the information below to achieve electromagnetic compatibility. The limits required by IEC-EN60974-10 may not be adequate to completely eliminate interference when the affected equipment is in close proximity or has a high degree of sensitivity. In such cases it may be necessary to use other measures to further reduce interference



WARNING

this Class A equipment is not intended for use in residential locations where the electrical power is provided by the public low-voltage supply system. There may be potential difficulties in ensuring electromagnetic compatibility in those locations, due to conducted as well as radiated disturbances.

INSTALLATION AND USE

The user is responsible for installing and using the arc welding equipment according to the manufacturer's instructions.

If electromagnetic disturbances are detected, then it shall be the responsibility of the user resolve the situation with the technical assistance of the manufacturer.

In some cases this remedial action may be as simple as earthing the welding circuit (see note). In other cases, it could involve constructing an electromagnetic screen enclosing the welding power source and the work complete with associated filters

In all cases electromagnetic disturbances shall be reduced to the point where they are no longer troublesome.

NOTE : The welding circuit may or may not be earthed for safety reasons. Changing the earthing arrangements should only be authorized by a person who is competent to assess whether the changes will increase the risk of injury, for example, by allowing parallel welding current return paths, which may damage the earth circuits of other equipment. Further guidance is given in IEC/TS 620812.

ASSESSMENT OF AREA

Before installing arc welding equipment the user shall make an assessment of potential electromagnetic problems in the surrounding area. The following shall be taken into account:

- A) other supply cables, control cables, signalling and telephone cables, above, below and adjacent to the arc welding equipment;
- B) radio and television transmitters and receivers;
- C) computer and other control equipment;
- D) safety critical equipment, for example guarding of industrial equipment;
- E) the health of the people around, for example the use of pacemakers and hearing aids;
- F) equipment used for calibration or measurement;
- G) the immunity of other equipment in the environment. The user shall ensure that other equipment being used in the environment is compatible. This may require additional protection measures;
- H) the time of day that welding or other activities are to be carried out.

The size of the surrounding area to be considered will depend on the structure of the building and other activities that are taking place. The surrounding area may extend beyond the boundaries of the premises.

METHODS OF REDUCING EMISSIONS

MAINTENANCE OF THE ARC WELDING EQUIPMENT

The arc welding equipment should be routinely maintained according to the manufacturer's recommendations. All access and service doors and covers should be closed and properly fastened when the arc welding equipment is in operation. The arc welding equipment should not be modified in any way, except for those changes and adjustments covered in the manufacturer's instructions.

WELDING CABLES

The welding cables should be kept as short as possible and should be positioned close together, running at or close to the floor level.

EQUIPOTENTIAL BONDING

Bonding of all metallic objects in the surrounding area should be considered. However, metallic objects bonded to the work piece will increase the risk that the operator could receive an electric shock by touching these metallic objects and the electrode at the same time. The operator should be insulated from all such bonded metallic objects.

EARTHING OF THE WORKPIECE

Where the workpiece is not bonded to earth for electrical safety, nor connected to earth because of its size and position, for example, ship's hull or building steelwork, a connection bonding the workpiece to earth may reduce emissions in some, but not all instances. Care should be taken to prevent the earthing of the workpiece increasing the risk of injury to users or damage to other electrical equipment.

Where necessary, the connection of the workpiece to earth should be made by a direct connection to the workpiece, but in some countries where direct connection is not permitted, the bonding should be achieved by suitable capacitance, selected according to national regulations.

SCREENING AND SHIELDING

Selective screening and shielding of other cables and equipment in the surrounding area may alleviate problems of interference. Screening of the entire welding area may be considered for special applications.





**BATTERY WITHOUT MAINTENANCE
(WHERE IT IS ASSEMBLED)**

The supplied battery is generally ready for use.
Connect the cable + (positive) to the pole + of the battery, by properly tightening the clamp.

In some models the battery should be activated.
To activate it (fill the included acid) please follow the instructions shown on the manual attached to the battery. When battery is activated, **DON'T** add any other liquid.



LUBRICANT

Please refer to the motor operating manual for the recommended viscosity.

Oil filling and level inspections must be carried out with the engine on a flat surface:

1. Remove oil filler cap (24);
2. Pour the oil in and reassemble oil cap;
3. Check the oil level using the dipstick (23); the oil level must be comprised between the minimum and maximum indicators.



ATTENTION

It is dangerous to supply too much lube oil to the engine because a sudden increase in engine rpm could be caused by its combustion.



DRY AIR FILTER

Check that the dry air filter is correctly installed and that there are no leaks around the filter which could lead to infiltrations of non-filtered air to the inside of the motor.



OIL BATH AIR FILTER

Fill the air filter using the same engine oil up to the level indicated on the filter.



FUEL



ATTENTION



Stop engine when fueling. Do not smoke or use open flames during refuelling operations, in order to avoid explosions or fire hazards.



Fuel fumes are highly toxic; carry out operations outdoors only, or in a well-ventilated environment. Avoid accidentally spilling fuel. Clean any eventual leaks before starting up motor.

Refill the tank with good quality diesel fuel, such as automobile type diesel fuel, for example.

For further details on the type of diesel fuel to use, see the motor operating manual supplied.

Do not fill the tank completely; leave a space of approx. 10 mm between the fuel level and the wall of the tank to allow for expansion.

In rigid environmental temperature conditions, use special winterized diesel fuels or specific additives in order to avoid the formation of paraffin.

ELECTRICAL CONNECTIONS



ATTENTION



A qualified electrician should carry out electrical connections according to the norms in force.

The electrical connection to the User system is a very important operation: safety and good operation of the genset and User system depend on a correct electrical connection.

Before supplying User system always check:

- that wires connecting gen-set to the user plant are suitable to the supplied voltage and are in accordance to the applicable rules;
- wire type, section and length have been calculated considering environment conditions and in force norms;
- ground is functioning correctly: earth fault relay device works only if this connection is operating;
- that direction of the phases corresponds to the user plant phase rotation, and none of the phases has been accidentally connected to neutral.



EARTHING WITHOUT GROUND FAULT INTERRUPTER

The protection against electric shock from contact indirect is ensured by the “electrical separation” with equipotential bonding between all the exposed conductive parts of the generating set.

The generating set is **NOT** equipped with a earth leakage circuit breaker because its windings are not connected to ground, hence the machine should **NOT** be intentionally connected to a grounding circuit.

The limitation of the extension of the electric circuit is very important for safety, do not power supply to electric plants with a length greater than 200 meters.

It is important that the power cords of the equipment are equipped with the protective conductor, yellow-green cable, in order to ensure the connection between the exposed conductive parts of the generating set and the equipment; this provision does not apply to the class II equipment (double insulation or reinforced insulation) recognizable by the symbol .

The cables must be suitable environment in which it operates. It should be noted that with temperatures below 5°C PVC cables become stiff and PVC insulation tends to cut to the first fold.

The protection by electrical separation is **NOT** suitable if the machine is destined to supply power complex plants or located in special environments with greater risk of electric shock.

In these cases it is necessary to adopt security measures electricity provided by law.

For EXAMPLE, you can install a GFI (Ground Fault Interrupter or Earth Leakage Circuit Breaker) high sensitivity 30mA, and grounding the Neutral of the generating set: this operation must be performed by a qualified electrician or at a authorized service provider.

The grounding of the generating set is now mandatory to ensure protection against indirect contact by means of the GFI.

Connect the generating set to an earthing system via a cable certain efficiency using the ground terminal (12) on the machine.

EARTHING WITH GROUND FAULT INTERRUPTER

The grounding connection to an earthed installation **is obligatory** for all models equipped with a differential switch (circuit breaker). In these groups the generator star point is generally connected to the machine’s earthing; by employing the TN or TT distribution system, the differential switch guarantees protection against indirect contacts.

In the case of powering complex installations requiring or employing additional electrical protection devices, the coordination between the protection devices must be verified.

For the grounding connection, use the terminal (12); comply to local and/or current regulations in force for electrical installations and safety

EARTHING WITH ISOMETER

Machines equipped with insulation resistance monitor allow intentionally not to connect the ground terminal PE (12) to an earthing system.

Located on the front of the machine the insulation resistance monitor has the function of continuously monitoring the ground insulation of live parts.

If the insulation resistance falls below the pre-set fault value, the insulation resistance monitor will interrupt the supply of the connected equipment.

It is important that the power cords of the devices are provided with the green-yellow circuit protective conductor, so as to ensure the bonding among all the grounds of the equipment and the ground of the machine; the latter provision does not apply to equipment with double insulation or reinforced insulation.

NOTE: it is possible to connect the PE terminal (12) to an own ground connection. In this case an IT earthing system is accomplished, this means with the active parts isolated from earth and the equipment cases grounded.

In this case, the insulation resistance monitor checks the insulation resistance of the active parts both towards case and ground, for example, the insulation towards ground of the power cables.



Check daily



NOTE

Do not alter the primary conditions of regulation and do not touch the sealed parts.

STARTING



By start-up of the generator the welding circuit is immediately operative, i.e. under voltage. Make sure that there are no unwished electrical contacts between the components of the outside welding circuit (electrode, electrode holder gun, workpiece, etc...).

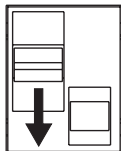

Verify that plugs will be disconnected or that the main switch will be off in order to assure the engine start without any electric load on.

- 1) Turn the starter key to position "ON". Make sure the battery charge and oil warning lights are lit.
- 2) Turn the start-up key (Q1) to the START position, once the engine is started up leave the key, it will reposition itself in "ON".



In case of unsuccessful start-up, do not insist for longer than 5 seconds. Wait 10 seconds before attempting another start-up.

- 3) After starting let the engine run with no load for a few minutes according to table.

TEMPERATURE	TIME
≤ - 20° C	5'
- 20° C / - 10° C	2'
- 10° C / - 5° C	1'
≥ - 5° C	20"

Start-up at low temperatures

The engine has a good start-up to temperatures of -10°C. For starting and use at lower temperatures, consult the engine use and maintenance manual or contact our Technical Assistance Service.

Please note that machines with autoidle (where provided), when the switch is placed on "autoidle", will remain at the minimum number of revolutions if no load is taken. Drawing power will automatically raise the number of engine revs to the nominal value and likewise the tension in the alternator. Instead, by setting the auto-idle signal to "max", the engine revs will immediately rise to the nominal value and likewise the tension in the alternator.

For the machines with manual accelerator, it is necessary to accelerate the motor manually in order to reach the nominal tension.

We advise to start the machine at the minimum rpm, moving the acceleration control (16) to the minimum position or the AUTOIDLE selector (18) to AUTOIDLE position.

STOPPING



For shutdown under normal conditions, proceed as follows:

Break the welding process in course. Break the production of a.c. auxiliary generation dividing the loads or opening the electrical protection interrupter. Let the engine run with no load for a few minutes.

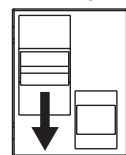

Turn to minimum rpm: AUTOIDLE selector (18) to AUTOIDLE position or acceleration control (16) to minimum position.

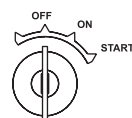

To stop the engine, turn the starter key (Q1) to the OFF position.

Emergency shutdown

To stop the group in a dangerous situation, press the emergency stop button (L5) (or turn the start key (Q1) to the OFF position). To reset the knob, turn it clockwise.

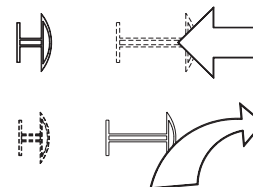

CAUTION

RUNNING-IN

During the first 50 hours of operation, do not use more than 60% of the maximum output power of the unit and check the oil level frequently, in any case please stick to the rules given in the engine use manual.



4A	Hydraulic oil level light	B2	Engine control unit EP2	U7	Engine control unit EP6
9	Welding socket (+)	B3	E.A.S. connector	V	Welding voltage voltmeter
10	Welding socket (-)	B4	Exclusion indicating light PTO HI	V4	Polarity inverter control
12	Earth terminal	B5	Auxiliary current push button	V5	Oil pressure indicator
15	A.C. socket	B6	Control panel power switch	W1	Remote control switch
16	Accelerator lever	C2	Fuel level light	W3	Selection push button 30 I/1' PTO HI
17	Feed pump	C3	E.A.S. PCB	W5	Battery voltmeter
19	48V D.C. socket	C6	Control unit for generating sets QEA	W9	Multifunction LED instrument
22	Engine air filter	C8	400V230V115V commutator	X1	Remote control socket
23	Oil level dipstick	D	Ground fault interrupter (30 mA)	X9	IntelliNano generating set test
24	Engine oil reservoir cap	D1	Engine control unit and economiser EP1	Y3	Button indicating light 20 I/1' PTO HI
24A	Hydraulic oil reservoir cap			Y5	Voltage switch
24B	Water filling cap	D2	Ammeter	Z2	Thermal-magnetic circuit breaker
25	Fuel prefilter	E2	Frequency meter	Z3	Selection push button 20 I/1' PTO HI
26	Fuel tank cap	E6	Frequency rpm regulator	Z5	Water temperature indicator
27	Muffler	E7	Voltmeter regulator	Z6	Digital multifunction meter
28	Stop control	F	Fuse	Z9	AMF25 generating set test
29	Engine protection cover	F3	Stop switch		
30	Engine cooling/alternator fan belt	F5	Warning light, high temperature		
31	Oil drain cap	F6	Arc-Force selector		
31A	Hydraulic oil drain cap	G1	Fuel level transmitter		
31B	Water drain cap	H2	Voltage commutator		
31C	Exhaust cap for tank fuel	H6	Fuel electro pump		
32	Button	H8	Engine control unit EP7		
33	Start button	I2	48V A.C. socket		
34	Booster socket 12V	I3	Welding scale switch		
34A	Booster socket 24V	I4	Preheating indicator		
35	Battery charge fuse	I5	Y/▲ switch		
36	Space for remote control	I6	Start Local/Remote selector		
37	Remote control	I8	AUTOIDLE switch		
42	Space for E.A.S.	L	A.C. output indicator		
42A	Space for PAC	L5	Emergency button		
47	Fuel pump	L6	Choke button		
49	Electric start socket	M	Hour counter		
54	Reset button PTO HI	M1	Warning level light		
55	Quick coupling m. PTO HI	M2	Contacto		
55A	Quick coupling f. PTO HI	M5	Engine control unit EP5		
56	Hydraulic oil filter	M6	CC/CV switch		
59	Battery charger thermal switch	N	Voltmeter		
59A	Engine thermal switch	N1	Battery charge warning light		
59B	Aux current thermal switch	N2	Thermal-magnetic circuit breaker/ Ground fault interrupter		
59C	Supply thermal switch wire feeder-42V				
59D	Pre-heater (spark plug) thermal switch	N5	Pre-heat push-button		
59E	Supply thermal switch oil/water heater	N6	Connector - wire feeder		
59F	Electropump thermal switch	O1	Oil pressure warning light/Oil alert		
63	No load voltage control	O8	V/A digital instruments and led VRD PCB		
65	Decompression lever	P	Welding arc regulator		
66	Choke control	P8	Water in fuel		
67A	Auxiliary / welding current control	Q1	Starter key		
68	Cellulosic electrodes control	Q3	Derivation box		
69A	Voltmeter relay	Q4	Battery charge sockets		
70	Warning lights	Q7	Welding selector mode		
71	Selecting knob	R3	Siren		
72	Load commut. push button	S	Welding ammeter		
73	Starting push button	S1	Battery		
74	Operating mode selector	S3	Engine control unit EP4		
75	Power on warning light	S6	Wire feeder supply switch		
76	Display	S7	Plug 230V singlephase		
79	Wire connection unit	T	Welding current regulator		
86	Selector	T4	Dirty air filter warning light/indicator		
86A	Setting confirmation	T5	Earth leakage relay		
87	Fuel valve	T7	Analogic instrument V/Hz		
88	Oil syringe	U	Current transformer		
89	Battery charge	U3	R.P.M. adjuster		
A3	Insulation monitoring	U4	Polarity inverter remote control		
A4	Button indicating light 30 I/1' PTO HI	U5	Release coil		

400V 230V VERSION

(Auto Idle version)

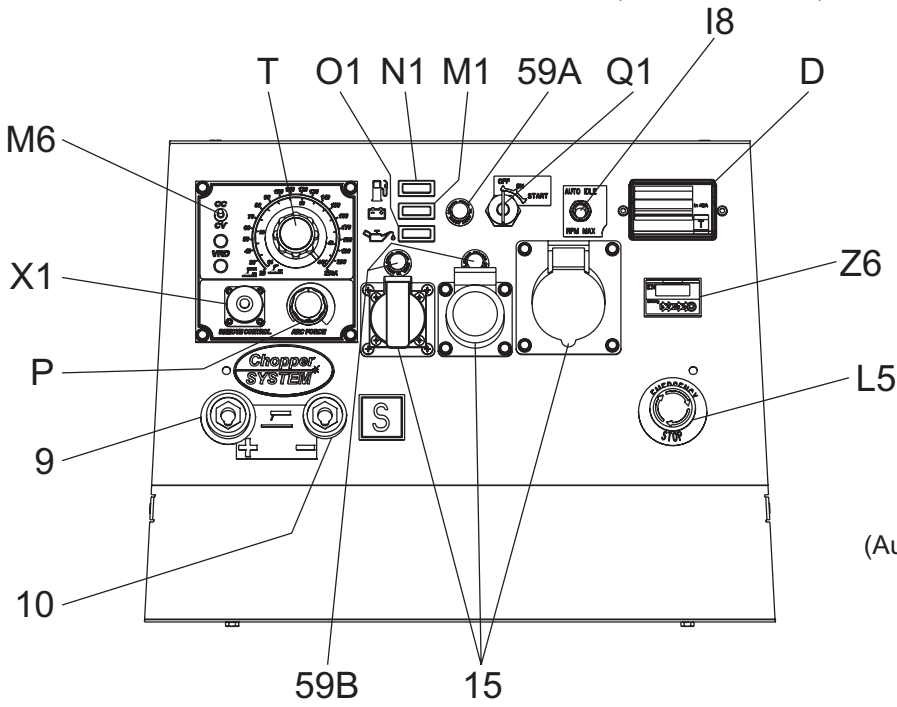

(Auto Idle version)

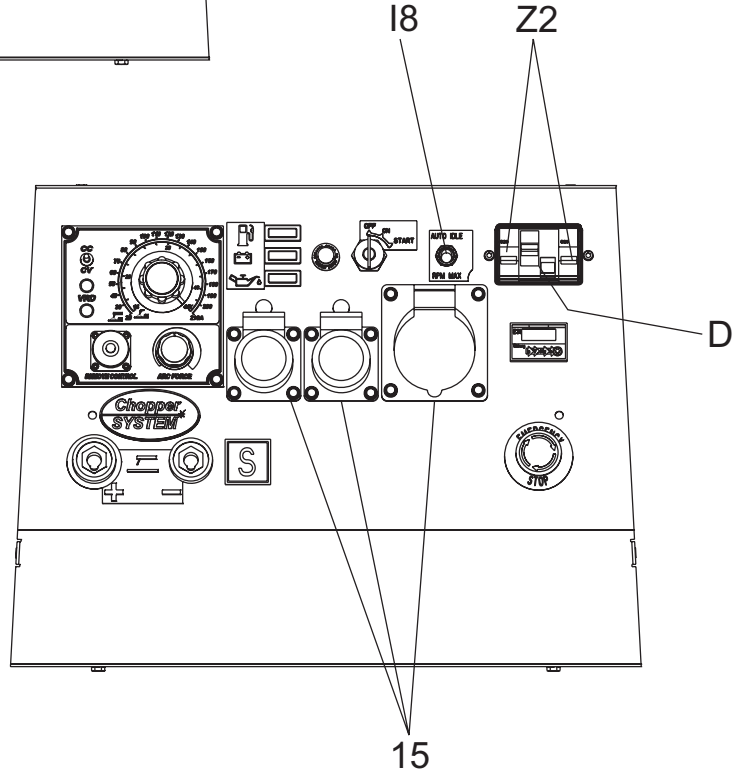

230V 110V VERSION

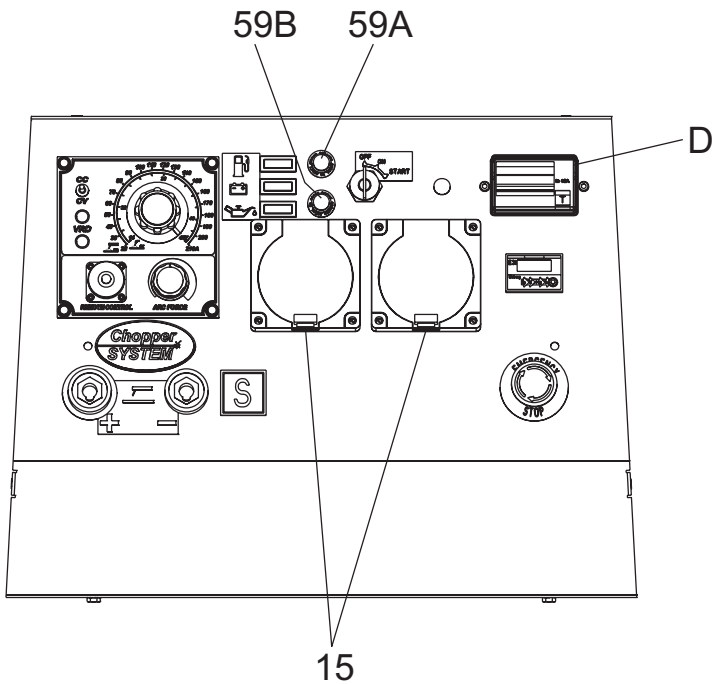
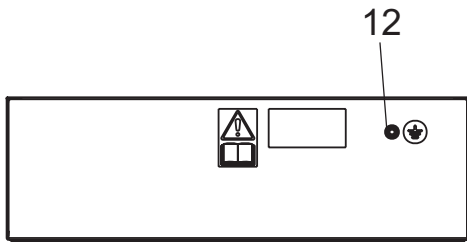

400V 230V AUS VERSION

Pos.	Description	Function
9	c.c. welding sockets (+)	Connection sockets for welding cables
10	c.c. welding sockets (-)	Connection sockets for welding cables
T	Welding current regulator	Allows the regulation of the welding current
P	Welding arc potentiometer	Turning clockwise the arc control is increased
X1	Remote control socket	Multiple connector for remote control.
Z6	Multifunction digital indicator	GE voltage VAC - GE Hz Frequency - Total hour counter - Resettable split time hour counter (for maintenance) - Battery voltage VDC
M6	Welding selector mode	Welding process selector: CC - CV
Q1	Starter key	Starting and stopping key of the generator
59A	Engine thermal switch	Protection against over-currents and short circuits in the engine electrical system.
O1	Fuel level gauge	Indicates fuel in the reservoir (%).
M1	Low oil pressure warning light	Indicates the shutdown of the motor due to low oil pressure
N1	Battery charger light	Signals a fault in the motor battery charging circuit
I8	AUTOIDLE switch	Enables the Autoidle function.
L5	Emergency button	To be pushed in case of danger. Immediate stop of the gen-set.
15	A.C. socket	AUX sockets for load connection.
D	Ground fault interrupter (30 mA)	Device for protection against not-direct contacts for TN and TT systems (neutral grounded to frame)
Z2	Thermal-magnetic circuit breaker	Protects the system connected to the outlets from overcurrent and shortcircuit.
59B	AUX thermal circuit breaker	Overcurrent protection of the equipments connected to the single-phase sockets
12	Earth terminal	Ground connection point for gen-set.

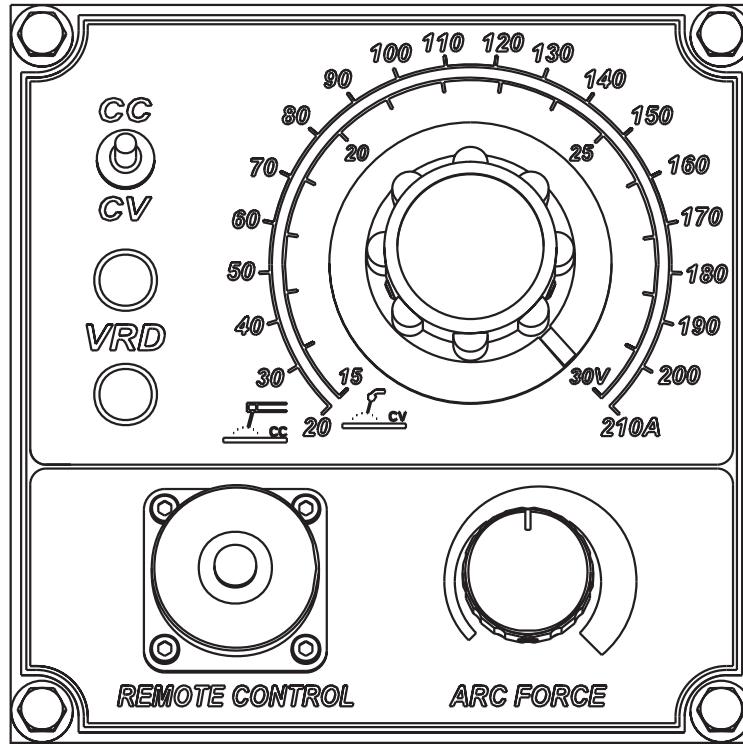

ENGLISH

ENGLISH

WELDING MODE SELECTION

The Welding Analogue Control unit (WAC) allows two possible control modes:

- Constant Current (CC)
- Constant Voltage (CV)

The welding option with C.V. characteristic is possible only on those models which support this mode of operation. On such models there is a switch which allows to select the desired mode.

The regulation with C.C. characteristic can be used to weld with various types of electrodes.
The regulation with C.V. characteristic is suitable for the wire welding, both naked and coated.

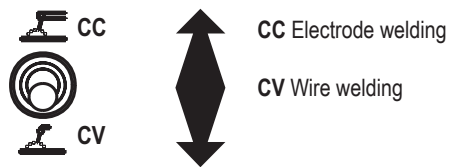

VOLTAGE AND CURRENT REGULATION

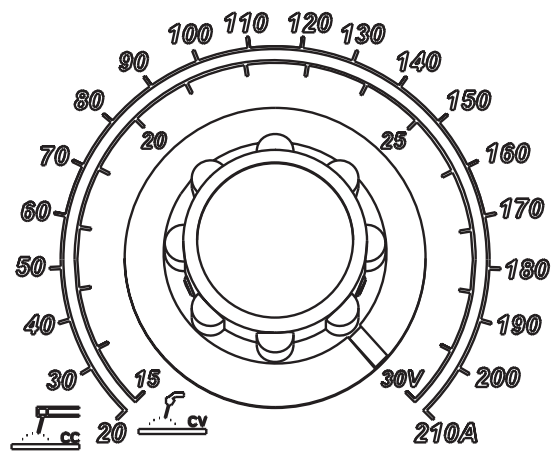

CURRENT REGULATION

When the CC/CV switch is in CC position the main knob sets the welding current within a range from 20A to 210A.

VOLTAGE REGULATION

With the CC/CV switch in CV position the main knob sets the welding voltage in a range between 14V - 44V.

ARC FORCE REGULATION

ARC FORCE

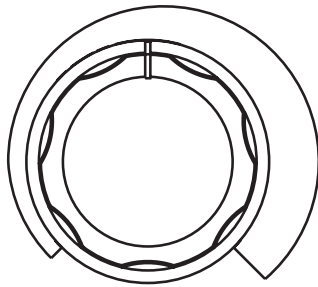

This type of regulation, possible only in CC mode, is accomplished by setting the position of the “arc force” switch and by adjusting the “arc force” knob. Both are located on the WAC panel.

For the welding processes which require a strictly constant current (e.g. TIG), the switch has to be placed in OFF position while the potentiometer position is irrelevant.

For the welding processes where a certain degree of arc force is suitable, the switch has to be positioned in ON and the potentiometer has to be properly adjusted, depending on the electrode type and the welding position.

REMOTE CONTROL

The WAC can accept the connection to a remote control box (optional) through a circular connector placed on the EAC panel.

After connection to a remote controller, the regulation function of the main knob is automatically switched to the knob on the remote controller.

The following table describes the pin function of the circular connector.

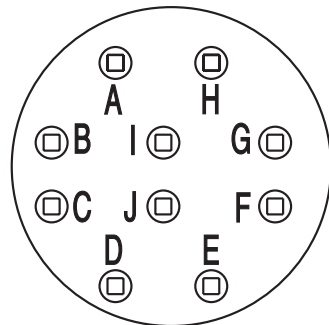
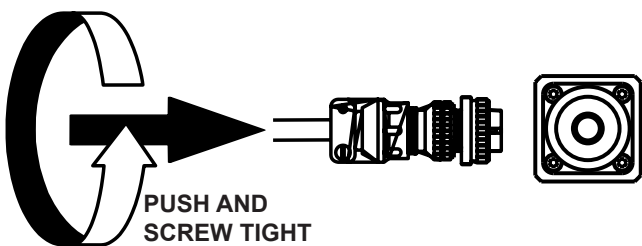

CONTACTS	DESCRIPTION
A (Ground)	To the RC1 potentiometer – GND terminal
B	To the RC1 potentiometer – V_{CONTR} terminal
C	To the RC1 potentiometer – V_{REF} terminal
D	Remote connection presence contact – wire bridge towards (C) cabling side
E	Non connected
F	Non connected
G	Welding enable contact in CV – enables when the contact is closed towards (I)
H	Negative pole of the welding voltage – to monitor the welding voltage by means of an instrument on the wire feeder
I	42Vac \pm 10% – phase A – for the power supply of the wire feeder
J	42Vac \pm 10% – phase B – for the power supply of the wire feeder

WIRE FEEDER

The welding control unit WAC is ready for connection to a wire feeder (optional), to be used in C.V. mode. The wire feeder can be supplied from a 42Vac \pm 10% source through the circular connector of the WAC. In this case, the same connector is used to interface the controller with a contact which enables the welding (conditioned by the torch trigger) and a remote potentiometer located on the wire feeder (where present). In case of wire feeders directly supplied from the welding power, the operation is anyway possible. With this type of wire feeders there is no need for any connection to the circular connector of the WAC.

VRD FUNCTION (VRD = Voltage Reduction Device)

The VRD function (present only on some versions) fulfils the purpose of drastically reducing the harm which may result to a person from inadvertent contact with the electrode during non-welding pauses. The VRD automatically switches the control mode in CV and sets the voltage to a safe value (typically <13V) each time the welding process is interrupted for a period longer than 3 sec.

The VRD function is active only in CC mode.



The proper operation of the VRD protection (in the models where it is implemented) is monitored by a couple of LEDs: one green and one red. During welding the red LED indicates that a condition of electrical risk is present. When the welding is stopped for more than 3 sec. the green LED turns on (and the red LED turns off) indicating that the VRD function is active. This means that the voltage on the electrode has been lowered to a safe value.

VRD ENABLING

It is possible to exclude or enable the VRD function by acting on the Dip Switches on the back of the WAC:

VRD ON: Dip Switch 1=OFF
Dip Switch 2=ON

VRD OFF: Dip Switch 1=ON
Dip Switch 2=OFF



This symbol (Norm EN 60974-1 security standards for arc welders) signifies that the welder can be used in areas with increased risk of electrical shock.

**ATTENTION**

The sockets, after the machine is started (see pages M21-26), also with no cables, are anyway under voltage.

**ATTENTION**

The areas, access of which is forbidden to unqualified personnel, are:

- the control switchboard (front)
- the exhaust of the endothermic engine - the welding process.

Check at the beginning of any work the electric parameters and/or the control placed on the front.

Make sure that the ground connection (12) is efficient (keep to installation local rules and/or to national laws), in order to integrate or ensure the working of various electric protection devices referring to the several distribution system TT/TN/IT, operation unnecessary for machine with isometer.

Fully insert the welding cable plugs into the corresponding sockets ("only gouging", 9+/10-) turning them clockwise to lock them in position.

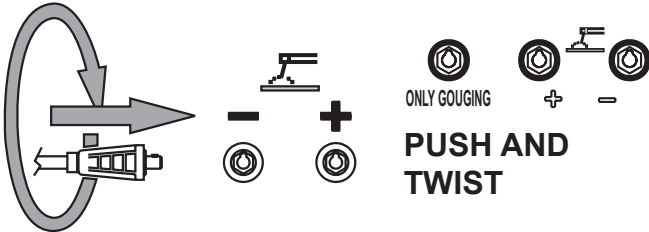

Make sure that the ground clamp, whose cable must be connected to the + or - terminal, depending on the type of electrode, makes a good connection and is near to the welding position.

Pay attention to the two polarities of the welding circuit, which must not come in electric contact between themselves.

When using the welder for air arc gouging connect the ground lead to the - socket and the gouging lead to the socket marked "only gouging" (if present).

MACHINES WITH E.V. PROTECTION

Accelerate the engine at max. with the accelerator lever (16). See page M 39.

MACHINE WITH E.P.2 PROTECTION (B2)

Accelerate the engine at max. with the accelerator lever (16) (when assembled). See page M 39

MACHINE WITH E.P.1 PROTECTION (D1)

See page M 39.1

**REMOTE CONTROL TC...**

See page M 38

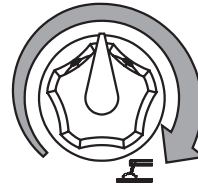
WELDING CURRENT REGULATOR

Position welding current adjusting knob (T) in correspondance of the chosen current value, so as to obtain the necessary amperage, taking into account the diameter and the type of the electrode. For technical data see page M1.6

**ATTENTION**

To reduce the risk of electromagnetic interferences, use the minimum length of welding cables and keep them near and down (ex. on the floor).

The welding operations must take place far from any sensitive electronic device. Make sure that the unit is earthed. (see M20 and/or M25). In case the interference should last, adapt further disposition, such as: move the unit, use screened cables, line filters, screen the entire work area.

In case the above mentioned operations are non sufficient, please contact our Technical Assistance Service.

**CAUTION**

With a welding cable length up to 20 m is suggested a section of 35 mm²; with longer cables a bigger section is required.



MACHINE WITH REDUCTION SCALE SWITCH

100% For small electrodes (up to Ø 3.25-130A and 4-200A) it is recommended to use the reduction scale switch (13) allowing a more accurate regulation of the welding current (lever position at 130 A and/or 200A).



When using electrodes of a diameter greater than 3.25 and/or 4 set the welding scale knob to 100% and/or max. position. The arc regulator (T) functions equally between both positions (100%-130A and/or 200A).



Protection fuse (when assembled): the fuse protects the electronic welding PCB in case the remote control is short circuited.

MACHINE WITH O.C.V.

65V Uo It permits to choose, according to the work to be done and/or the electrode type used, the best O.C.V.

**MACHINE WITH POLARITY INVERTER**

+ Polarity switch It permits to have at the electrode holder the positive or negative polarity of the welding diode bridge.
- It is used above all in the first run with cellulosic electrodes to lower the bath temperature and so doing ease up the welding on pipes of small thickness

**MACHINE WITH BASIC CURRENT "BC"**

ON Positioning the switch on „ON“, is obtained a low voltage welding current which keeps, always, the lit arc necessary for some types of cellulosic electrodes or when a high penetration is wanted.
OFF For electrodes of basic or rutile type, position the switch on "OFF", the welding current will always remain constant.

**"CC/CV" MODELS**

CC These models can be used with electrodes or for TIG welding by selecting the CC (constant current) mode, and with solid wire (MIG, MAG) or flux cored wire selecting the CV (constant voltage) mode. The mode of operation is selected by a switch on the front panel.

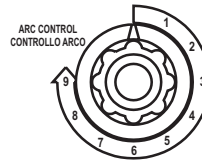
**MACHINE WITH ARC CONTROL OR SELECTOR "ARC FORCE"****ARC FORCE**

Set the welding arc using adjuster knob (P) so as to obtain, for the chosen current value, the best arc characteristic according to the electrode type and to the work to be performed. On machines with an Arc Force selector, the same result can be obtained by turning the selector "ON" or "OFF". When switched "ON" a base current is applied to the welding current output acting as a sort of "automatic" arc forcing that does not need to be regulated.

For technical data see page M1.6

At the end of every welding process and/or work, proceed with all the use operations **in inverted sense**.

To stop the machine see pages M 22-27.

**WARNING**

It is absolutely forbidden to connect the unit to the public mains and/or another electrical power source .



Access forbidden to area adjacent to electricity-generating group for all non-authorized personnel.

**WARNING**

For the canopy generator sets provided with doors, the following instruction shall be observed. During the normal operation, the doors of the engine compartment and/or the electrical box shall be kept closed, locked up if possible, as they must be considered in all respects as protection barriers. The access to the internal parts shall occur for maintenance purposes only, by qualified personnel and, in any case, when the engine is stopped.

The electricity-generating groups are to be considered electrical energy producing stations. The dangers of electrical energy must be considered together with those related to the presence of chemical substances (fuels, oils, etc.), rotating parts and waste products (fumes, discharge gases, heat, etc.).

GENERATION IN AC (ALTERNATING CURRENT)

Before each work session check the efficiency of the ground connection for the electricity-generating group if the distribution system adopted requires it, such as, for example, the TT and TN systems.

Check that the electrical specifications for the units to be powered - voltage, power, frequency - are compatible with those of the generator. Values that are too high or too low for voltage and frequency can damage electrical equipment irreparably. In some cases, for the powering of three-phase loads, it is necessary to ensure that the cyclic direction of the phases corresponds to the installation's requirements.

Connect the electric devices to be powered to the AC sockets, using suitable plugs and cables in prime condition.

Before starting up the group, make certain no dangerous situations exist on the installation to be powered.

Check that the thermal-magnetic switch (Z2) is in the OFF position (input lever in downward position).

Start up the electricity-generating group, positioning the thermal-magnetic switch (Z2) and differential switch (D) to ON (input lever in upward position).

Before powering on the utilities, check that the voltmeter (N) and frequency meter (E2) indicate nominal values; in addition, check on the voltmeter change-over switch (H2) (where it is assembled) that the three line voltages are the same.

In the absence of a load, the values for voltage and frequency can be greater than their nominal values. See sections on VOLTAGE and FREQUENCY.

OPERATING CONDITIONS**POWER**

The electrical power expressed in kVA on an electricity-generating group is the available output power to the reference environmental conditions and nominal values for: voltage, frequency, power factors ($\cos \varphi$).

During the use of the electricity-generating group NEVER EXCEED the power indications, paying careful attention when several loads are powered simultaneously.

VOLTAGE

In some types of generators (asynchronous) the no-load voltage can be even higher than 10% with respect to its nominal value; for example, for nominal voltage, three-phase 400Vac or single-phase 230Vac, the no-load voltage can be between 425-440V (three-phase) and 240-252V (single-phase).

The full load voltage could also be 10% lower than its nominal value with balanced loads and with a rotation speed variation of less than 4%.

FREQUENCY

The frequency is a parameter that is directly dependent on the motor's rotation speed. Depending on the type of alternator, 2 or 4 pole, we will have a frequency of 50/60 Hz with a rotation speed of 3000/3600 or 1500/1800 revolutions per minute.

The frequency, and therefore the number of motor revolutions, is maintained constant by the motor's speed regulation system. Generally, this regulator is of a mechanical type and presents a droop from no-load to nominal load which is less than 5 % (static or droop), while under static conditions precision is maintained within $\pm 1\%$. Therefore, for generators at 50Hz the no-load frequency can be 52-52.5 Hz, while for generators at 60Hz the no-load frequency can be 62.5-63Hz.

In some motors or for special requirements the speed regulator is electronic; in these cases, precision under static operating conditions attains $\pm 0.25\%$, and the frequency is maintained constant in operation from no-load to load (isochronal operation).

POWER FACTOR - $\cos \varphi$

The power factor is a value which depends on the load's electrical specifications; it indicates the ratio between the Active Power (kW) and Apparent Power (kVA). The apparent power is the total power necessary for the load, achieved from the sum of the active power supplied by the motor (after the alternator has transformed the mechanical power into electrical power), and the Reactive Power (kVAR) supplied by the alternator. The nominal value for the power factor is $\cos \varphi = 0,8$; for different values comprised between 0.8 and 1 it is important during usage not to exceed the declared active power (kW), so as to not overload the electricity-generating group motor; the apparent power (kVA) will diminish proportionally to the increase of $\cos \varphi$. For $\cos \varphi$ values of less than 0.8 the alternator must be downgraded, since at equal apparent power the alternator should supply a greater reactive power. For reduction coefficients, contact the Technical Service Department.

STARTING ELECTRIC MOTORS

The starting of electric motors by a generator can be critical due to the high starting currents that the electric motor requires (I_{avv.} = Up to 8-10 times the rated current I_n).

With asynchronous alternators, the motor starting current must not exceed the rated current of the alternator, which is why asynchronous alternators are not recommended for starting electric motors.



ELECTRIC PROTECTIONS

THERMAL-MAGNETIC SWITCH

NOTE: for some types of alternators (asynchronous alternators) it is not necessary to protect the three-phase output against short circuits and overcurrents, as the asynchronous alternator self-protects itself.

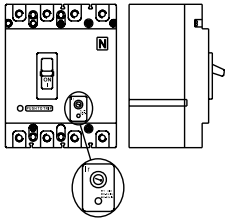

The electricity-generating group is protected against short-circuits and against overloads by a thermal-magnetic switch (Z2) situated upstream from the installation. Operating currents, both thermic and magnetic, can be fixed or adjustable in relation to the switch model.

In models with adjustable operating current **do not modify** the settings, since doing so can compromise the installation's protection or the electricity-generating group's output characteristics. For eventual variations, contact our Technical Service Department.

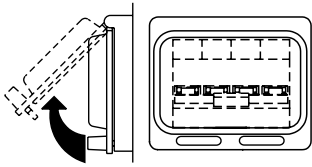

The intervention of the protection feature against overloads is not instantaneous, but follows a current overload/time outline; the greater the overload the less

the intervention. Furthermore, keep in mind that the nominal operating current refers to an operating temperature of 30°C, so that each variation of 10°C roughly corresponds to a variation of 5% on the value of nominal current.

In case of an intervention on the part of the thermal magnetic protection device, check that the total absorption does not exceed the electricity-generating group's nominal current.

DIFFERENTIAL SWITCH

The differential switch or differential relay guarantee protection against indirect contacts due to malfunction currents towards the ground. When the device detects a malfunction current that is higher than the nominal current or the set current, it intervenes by cutting off power to the circuit connected.

In the case of an intervention by the differential switch, check that there are no sheathing defects in the installation: connection cables, sockets and plugs, utilities connected.

Before each work session, check the operation of the differential protection device by pressing the test key. The

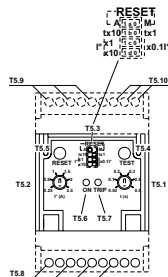
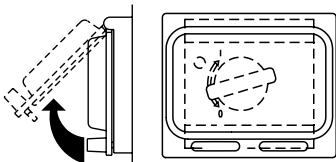

electricity-generating group must be in operation, and the lever on the differential switch must be in the ON position.

THERMIC PROTECTION

Generally present to protect against overloads on an individual power socket c.a.

When the nominal operating current has been exceeded, the protection device intervenes by cutting off power to the socket. The intervention of the protection device against overloads is not instantaneous, but follows a current overload/time outline; the greater the overload the less the intervention.

In case of an intervention, check that the current absorbed by the load does not exceed the protection's nominal operating current. Allow the protection to cool off for a few minutes before resetting by pressing the central pole.



ATTENTION

Do not keep the central pole on the thermic protection forcefully pressed to prevent its intervention.

SIMULTANEOUS USE

The welder's alternator permits the simultaneous use of auxiliary power and welding current. The auxiliary power available to the AC plugs (15) diminishes as the welding current drawn increases.

The table on page M52 TECHNICAL SPECIFICATIONS shows the amount of auxiliary power available as the welding current varies.

COMBINED USE

The output available from the various auxiliary power sockets is limited, not only by the declared output of the unit but also by the capacity of each individual socket.



The information here below are to be intended only as indicative since the above norm is much larger.
For further details please see the specific norms and/or the manufacturers of the product to be used in the welding process.

RUTILE ELECTRODES: E 6013

Easily removable fluid slag, suitable for welding in all position.
Rutile electrodes weld in d.c. with both polarities (electrode holder at + or -) and in a.c..
Suitable for soft steels R-38/45 kg/mm². Also for soft steels of lower quality.

BASIC ELECTRODES: E 7015

Basic electrodes weld only in d.c. with inverse polarity (+ on the electrode holder) ; there are also types for a.c.
Suitable for impure carbon steels. Weld in all position.

HIGH YIELD BASIC ELECTRODES: E 7018

The iron contained in the coating increases the quality of metal added. Good mechanical properties. Weld in all position. Electrode holder at + (inverse polarity). Weld deposit of nice aspect, also vertical. Workable; high yield.
Suitable for steels with high contents of sulphur (impurities).

CELLULOSIC ELECTRODES: E 6010

Cellulosic electrodes weld only in d.c. with polarity + electrode holder - ground clamp.
Special for steels run on pipes with R max 55 kg/mm². Weld in all position. volatile slag.

ELECTRODES IDENTIFICATION ACCORDING TO A.W.S. STANDARDS

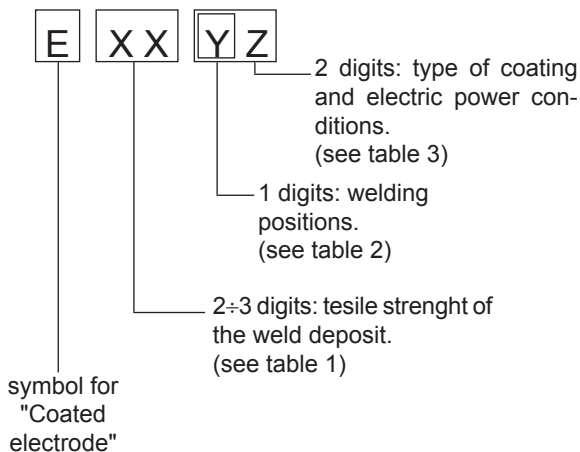

Number	Strength	
	K.s.l.	Kg/mm ²
60	60.000	42
70	70.000	49
80	80.000	56
90	90.000	63
100	100.000	70
110	110.000	77
120	120.000	84

Table 1

1	for all positions
2	for plane and vertical
3	for plane position only

Table 2



N°	Description
10	Cellulose electrodes for d.c.
11	Cellulose electrodes for a.c.
12	Rutile electrode for d.c.
13	Rutile electrode for a.c.
14	High yield rutile electrodes
15	Basic electrodes for d.c.
16	Basic electrodes for a.c.
18	High yield basic electrodes for d.c. (inverse polarity)
20	Acid electrodes for flat or front position welding for d.c. (- pole) and for a.c.
24	High yield rutile electrodes for flat or front plane position welding for d.c. and a.c.
27	High yield acid electrodes for flat or front plane position welding for d.c. (- pole) and a.c..
28	High yield basic electrodes for flat or front plane position welding for d.c. (inverse polarity)
30	Extra high yield acid electrodes, extra high penetration if required, for flat position welding only for d.c. (- pole) and a.c.

Table 3

PROBLEM	ASSOCIATED SYMPTOMS	POSSIBLE CAUSE	VERIFICATIONS	WHAT TO DO
P1 No welding arc (applicable only to machines with WAC)	No open circuit voltage	Failed power supply within the welding control board (WAC)	With the machine running, by means of a multimeter, check if there is a voltage of 5VDC \pm 0,125V between the contacts A (-) and C (+) on the circular connector of the WAC. In case of lack of voltage or condition not satisfied consider the suggested action.	Replace the welding control board of the WAC
P2 No welding arc (applicable only to machines without WAC)	No open circuit voltage	Failed power supply within the welding control board (WAC)	With the machine running, by means of a multimeter, check if there is a voltage of 5VDC \pm 0,125V between the contacts 1 (-) and 2 (+) on the circular connector of the front panel, after having set the remote control switch in ON position. In case of lack of voltage or condition not satisfied consider the suggested action.	Replace the welding control board
P3 No welding arc	No open circuit voltage	Failure in the control or drive circuits of the welding control board	In order to check the proper operation of these circuits it is necessary to use specific test and troubleshooting tools. Anyway, a visual inspection could be enough to localise possible damages caused by a failure. In case of evidence of damages consider the suggested action.	Replace the welding control board ATTENTION For the CS 230 only, there is a risk of failure propagation towards the chopper. Before replacing this board please check that the chopper works properly. If not replace both.
P4 Lack of welding current control	Full welding power (without current control) regardless of the knob position	Failure in the control or drive circuits of the welding control board	In order to check the proper operation of these circuits it is necessary to use specific test and troubleshooting tools. Anyway, a visual inspection could be enough to localise possible damages caused by a failure. In case of evidence of damages consider the suggested action.	Replace the welding control board ATTENTION For the CS 230 only, there is a risk of failure propagation towards the chopper. Before replacing this board please check that the chopper works properly. If not replace both.
P5 No welding arc	No open circuit voltage or welding available current low or negligible. With auto-idle installed, the r.p.m. never slows-down to idle.	Hall sensor failed	Disconnect the Hall sensor from the welding control board (on the WAC or within the electrical box, as applicable) and check that, in this condition, the open circuit voltage reading is correct. When the VRD is installed, the voltage goes to VRD value. If a resistive load bank is available, check that it is possible draw power (do not exceed 100A). If the Auto-idle is installed, in this condition the machine does not exit the idle. In any case, don't try to weld with the Hall sensor disconnected. If the test gives positive result, consider the indicated action.	Replace the Hall sensor

PROBLEM	ASSOCIATED SYMPTOMS	POSSIBLE CAUSE	VERIFICATIONS	WHAT TO DO
P6 Lack of voltage control in CV mode (applicable to the CC-CV machines provided with filter board)	The open circuit voltage in CV mode is the same as for the CC mode, regardless of the control knob position	Failure in the EMC filter board on the welding sockets	Check by means of a multimeter (stopped machine) the resistance value between positive welding socket and the corresponding faston connector on the filter board. The condition to check is: ohmic value between + welding socket and + board faston (the one to which the red cables are connected) < 4 ohm In case of condition not satisfied take the indicated corrective action.	Replace the EMC filter board
P7 No welding arc (applicable to the machines provided with the filter board on the welding sockets)	The open circuit voltage is zero	Failure in the EMC filter board on the welding sockets	Check by means of a multimeter (stopped machine) the resistance value between positive welding socket and the corresponding faston connector on the filter board. The condition to check is: ohmic value between - welding socket and - board faston (the one to which the black cables are connected) < 4 ohm In case of condition not satisfied take the indicated corrective action.	Replace the EMC filter board
P8 Minimum welding current in CC mode too high (applicable to the machines provided with the filter board on the welding sockets)	The welding current in CC mode with the knob at beginning of scale is too high and changes when turning the arc force knob (if present, switch in ON position)	Failure in the EMC filter board on the welding sockets	Check by means of a multimeter (stopped machine) the resistance value between positive welding socket and the corresponding faston connector on the filter board. The condition to check is: ohmic value between + welding socket and + board faston (the one to which the red cables are connected) < 4 ohm In case of condition not satisfied take the indicated corrective action.	Replace the EMC filter board
P9 Minimum welding current in CC mode too high	The welding current in CC mode with the knob at beginning of scale is too high and changes when turning the arc force knob (if present, switch in ON position)	Cable interruption between the WAC or the welding control board (as applicable depending on the machine type) and the welding sockets	With the machine stopped, extract the connector plugged to J1 of the WAC / Welding control board (as applicable depending on the machine type). Check by means of a multimeter the continuity between pin 6 of the connector and the positive welding socket. The resistive value shall be < 4 ohm if there is a filter board behind the sockets, otherwise shall be < 0.5 ohm. In case of condition not satisfied take the indicated corrective action.	Fix the cabling or replace it.
P10 No welding arc	The open circuit voltage is zero	Cable interruption between the WAC or the welding control board (as applicable depending on the machine type) and the welding sockets	With the machine stopped, extract the connector plugged to J1 of the WAC / Welding control board (as applicable depending on the machine type). Check by means of a multimeter the continuity between pin 5 of the connector and the negative welding socket. The resistive value shall be < 4 ohm if there is a filter board behind the sockets, otherwise shall be < 0.5 ohm. In case of condition not satisfied take the indicated corrective action	Fix the cabling or replace it.

PROBLEM	ASSOCIATED SYMPTOMS	POSSIBLE CAUSE	VERIFICATIONS	WHAT TO DO
P11 Lack of welding current control	Full welding power (without current control) regardless of the knob position. When the auto-idle is installed, the machine remains at low r.p.m.	Hall sensor failed	In order to check the proper operation of the Hall sensor it is necessary to use specific test and troubleshooting tools. Anyway, a visual inspection could be enough to localise possible damages, with particular reference to possible wear of the cable end coming out of the Hall sensor potting. Please check also the connector contacts crimping at the opposite end of the cable. In case of evidence of damages consider the suggested action	Replace the Hall sensor
P12 Lack of welding current control (applicable only to CS 350)	Full welding power (without current control) regardless of the knob position	Chopper and/or driver board failed	Disconnect the chopper cable from the connector J3 of the WAC. Check that the open circuit voltage is < 1V. If not put a light resistive load at the welding output (few kohms are enough) and check again the previous condition. If it is not satisfied the chopper is faulty. If a welding load bank and a clamp DC amp meter are available, another test can be done to localise the failed section/s. To this purpose set the load bank for a current of a few tens of amps and measure the current at the output of each chopper section (the group of cables which connects the chopper to one end of the welding current leveling reactor). The sections through which the current flows are failed or improperly driven by the driver board. If the test confirms this type of failure consider the suggested corrective action.	Replace the chopper and the driver board
P13 Lack of welding current control (applicable only to CS 230)	Full welding power (without current control) regardless of the knob position	Chopper faulty	Disconnect the chopper cable from the connector J3 of the WAC. Check that the open circuit voltage is < 1V. If not put a light resistive load at the welding output (few kohms are enough) and check again the previous condition. If it is not satisfied the chopper is faulty. In this case consider the suggested corrective action.	Replace the chopper
P14 Knob irregular or missing current adjustment	When turning the knob the current setting (and the voltage setting, if applicable) do not change or change irregularly	The potentiometer which regulates the welding current (and the welding voltage, when applicable) is faulty	Check if the regulation through remote control works properly. If confirmed, consider the suggested corrective action.	Replace the potentiometer

 WARNING		
	<ul style="list-style-type: none"> • Have qualified personnel do maintenance and troubleshooting work. • Stop the engine before doing any work inside the machine. If for any reason the machine must be operated while working inside, pay attention moving parts, hot parts (exhaust manifold and muffler, etc.) electrical parts which may be unprotected when the machine is open. • Remove guards only when necessary to perform maintenance, and replace them when the maintenance requiring their removal is complete. • Please wear the appropriate clothing and make use of the PPE (Personal Protective Equipment), according to the type of intervention (protective gloves, insulated gloves, glasses). • Do not modify the components if not authorized. <p>- See pag. M1.1 -</p>	
MOVING PARTS can injure		HOT surface can hurt you

NOTE

By maintenance at care of the utilizer we intend all the operatios concerning the verification of mechanical parts, electrical parts and of the fluids subject to use or consumption during the normal operation of the machine.

For what concerns the fluids we must consider as maintenance even the periodical change and or the refills eventually necessary.

Maintenance operations also include machine cleaning operations when carried out on a periodic basis outside of the normal work cycle.

The repairs **cannot be considered** among the maintenance activities, i.e. the replacement of parts subject to occasional damages and the replacement of electric and mechanic components consumed in normal use, by the Assistance Authorized Center as well as by manufacturer.

The replacement of tires (for machines equipped with trolleys) must be considered as repair since it is not delivered as standard equipment any lifting system.

The periodic maintenance should be performed according to the schedule shown in the engine manual. An optional hour counter (M) is available to simplify the determination of the working hours.

VENTILATION

Make certain there are no obstructions (rags, leaves or other) in the air inlet and outlet openings on the machine, alternator and motor.

ELECTRICAL PANELS

Check condition of cables and connections daily. Clean periodically using a vacuum cleaner, **DO NOT USE COMPRESSED AIR.**

DECALS AND LABELS

*All warning and decals should be checked once a year and **replaced** if missing or unreadable.*

STRENUOUS OPERATING CONDITIONS



Under extreme operating conditions (frequent stops and starts, dusty environment, cold weather, extended periods of no load operation, fuel with over 0.5% sulphur content) do maintenance more frequently.

**BATTERY WITHOUT MAINTENANCE
DO NOT OPEN THE BATTERY**

The battery is charged automatically from the battery charger circuit supplied with the engine.

Check the state of the battery from the colour of the warning light which is in the upper part.

- Green colour: battery OK
- Black colour: battery to be recharged
- White colour: battery to be replaced

 IMPORTANT
 <p>In the maintenance operations avoid that polluting substances, liquids, exhausted oils, etc. bring damage to people or things or can cause negative effects to surroundings, health or safety respecting completely the laws and/or dispositions in force in the place.</p>

ENGINE AND ALTERNATOR

PLEASE REFER TO THE SPECIFIC MANUALS PROVIDED.

Every engine and alternator manufacturer has maintenance intervals and specific checks for each model: it is necessary to consult the specific engine or alternator USER AND MAINTENANCE manual.

 NOTE
<p>THE ENGINE PROTECTION NOT WORK WHEN THE OIL IS OF LOW QUALITY BECAUSE NOT CHARGED REGULARLY AT INTERVALS AS PRESCRIBED IN THE OWNER'S ENGINE MANUAL.</p>



STORAGE

In case the machine should not be used for more than 30 days, make sure that the room in which it is stored presents a suitable shelter from heat sources, weather changes or anything which can cause rust, corrosion or damages to the machine.

☛ Have **qualified** personnel prepare the machine for storage.

GASOLINE ENGINE

Start the engine: It will run until it stops due to the lack of fuel.

Drain the oil from the engine sump and fill it with new oil (see page M25).

Pour about 10 cc of oil into the spark plug hole and screw the spark plug, after having rotated the crankshaft several times.

Rotate the crankshaft slowly until you feel a certain compression, then leave it.

In case the battery, for the electric start, is assembled, disconnect it.

Clean the covers and all the other parts of the machine carefully.

Protect the machine with a plastic hood and store it in a dry place.

DIESEL ENGINE

For short periods of time it is advisable, about every 10 days, to make the machine work with load for 15-30 minutes, for a correct distribution of the lubricant, to recharge the battery and to prevent any possible blocking of the injection system.

For long periods of inactivity, turn to the after sales service of the engine manufacturer.

Clean the covers and all the other parts of the machine carefully.

Protect the machine with a plastic hood and store it in a dry place.

**IMPORTANT**

In the storage and cust off operations avoid that polluting substances, liquids, exhausted oils, etc. bring damage to people or things or can cause negative effects to surroundings, health or safety respecting completely the laws and/or dispositions in force in the place.

DISASSEMBLE

☛ Have **qualified** personnel disassemble the machine and dispose of the parts, including the oil, fuel, etc., in a correct manner when it is to be taken out of service.

As disassemble we intend all operations to be made, at utilizer's care, at the end of the use of the machine.

This comprises the dismantling of the machine, the subdivision of the several components for a further reutilization or for getting rid of them, the eventual packing and transportation of the eliminated parts up to their delivery to the store, or to the bureau entrusted to the disassemble or to the storage office, etc.

The several operations concerning the disassemble, involve the manipulation of fluids potentially dangerous such as: lubricating oil and battery electrolyte.

The dismantling of metallic parts liable to cause injuries or wounds, must be made wearing heavy gloves and using suitable tools.

The getting rid of the various components of the machine must be made accordingly to rules in force of law a/o local rules.

Particular attention must be paid when getting rid of: lubricating oils, battery electrolyte, and inflammable liquids such as fuel, cooling liquid.

The machine user is responsible for the observance of the norms concerning the environment conditions with regard to the elimination of the machine being disassemble and of all its components.

In case the machine should be disassemble without any previous disassembly it is however compulsory to remove:



- tank fuel
- engine lubricating oil
- cooling liquid from the engine
- battery

NOTE: The manufacturer is involved with disassembling the machine **only** for the second hand ones, when not reparable.

This, of course, after authorization.

In case of necessity for first aid and fire prevention, see page M2.1.



GENERATOR		CS 230 YSX CC/CV
Three-phase generation	6 kVA / 400 V / 8.7 A	
Single-phase generation	5 kVA / 230 V / 21.7 A	
Single-phase generation	2.5 kVA / 110 V / 22.7 A	
Frequency	50 Hz	
ALTERNATOR		Self-excited, self-regulated, brushless
Type	Three-phase, asynchronous	
Insulating class	H	
ENGINE		
Mark / Model	Yanmar L 100	
Type / Cooling system	Diesel 4-Stroke / Air	
Cylinders / Displacement	1 / 435 cm ³	
Output max	6.3 kW (8.5 HP)	
Speed	3000 rpm	
Fuel consumption (welding 60%)	1 l/h	
Engine oil capacity	1.6 l	
Starter	Electric	
GENERAL SPECIFICATIONS		
Tank capacity	23 l	
Running time (welding 60%)	23 h	
Protection	IP 23	
*Dimensions / max. Lxwxh (mm)	1020x645x930	
*Weight	230 kg	
Measured acoustic power LwA (pressure LpA)	91 dB(A) (66 dB(A) @ 7 m) 	
Guaranteed acoustic power LwA (pressure LpA)	92 dB(A) (67 dB(A) @ 7 m) 	
<i>* Dimensions and weight are inclusive of all parts without wheels and towbar</i>		

POWER

Declared power according to ISO 3046-1 (temperature 25°C, 30% relative humidity, altitude 100 m above sea level).

It's admitted overload of 10% each hour every 12 h.

In an **approximative** way one reduces: of 1% every 100 m altitude and of 2.5% for every 5°C above 25°C.

ACOUSTIC POWER LEVEL

ATTENTION: The concrete risk due to the machine depends on the conditions in which it is used. Therefore, it is up to the end-user and under his direct responsibility to make a correct evaluation of the same risk and to adopt specific precautions (for instance, adopting a I.P.D. -Individual Protection Device)

Acoustic Noise Level (LwA) - Measure Unit dB(A): it stands for acoustic noise released in a certain delay of time. This is not submitted to the distance of measurement.

Acoustic Pressure (Lp) - Measure Unit dB(A): it measures the pressure originated by sound waves emission. Its value changes in proportion to the distance of measurement.

The here below table shows examples of acoustic pressure (Lp) at different distances from a machine with Acoustic Noise Level (LwA) of 95 dB(A)

Lp a 1 meter = 95 dB(A) - 8 dB(A) = 87 dB(A)

Lp a 4 meters = 95 dB(A) - 20 dB(A) = 75 dB(A)

Lp a 7 meters = 95 dB(A) - 25 dB(A) = 70 dB(A)

Lp a 10 meters = 95 dB(A) - 28 dB(A) = 67 dB(A)

PLEASE NOTE: the symbol  when with acoustic noise values, indicates that the device respects noise emission limits according to 2000/14/CE directive.

D.C. WELDING

Duty cycle	210A 60% - 180 A 100%
Welding current regulation	20 ÷ 210 A
Open circuit voltage	65V

C.V. WELDING

Welding current	210 A 60% - 180 A 100%
Welding voltage regulation	14 ÷ 44V

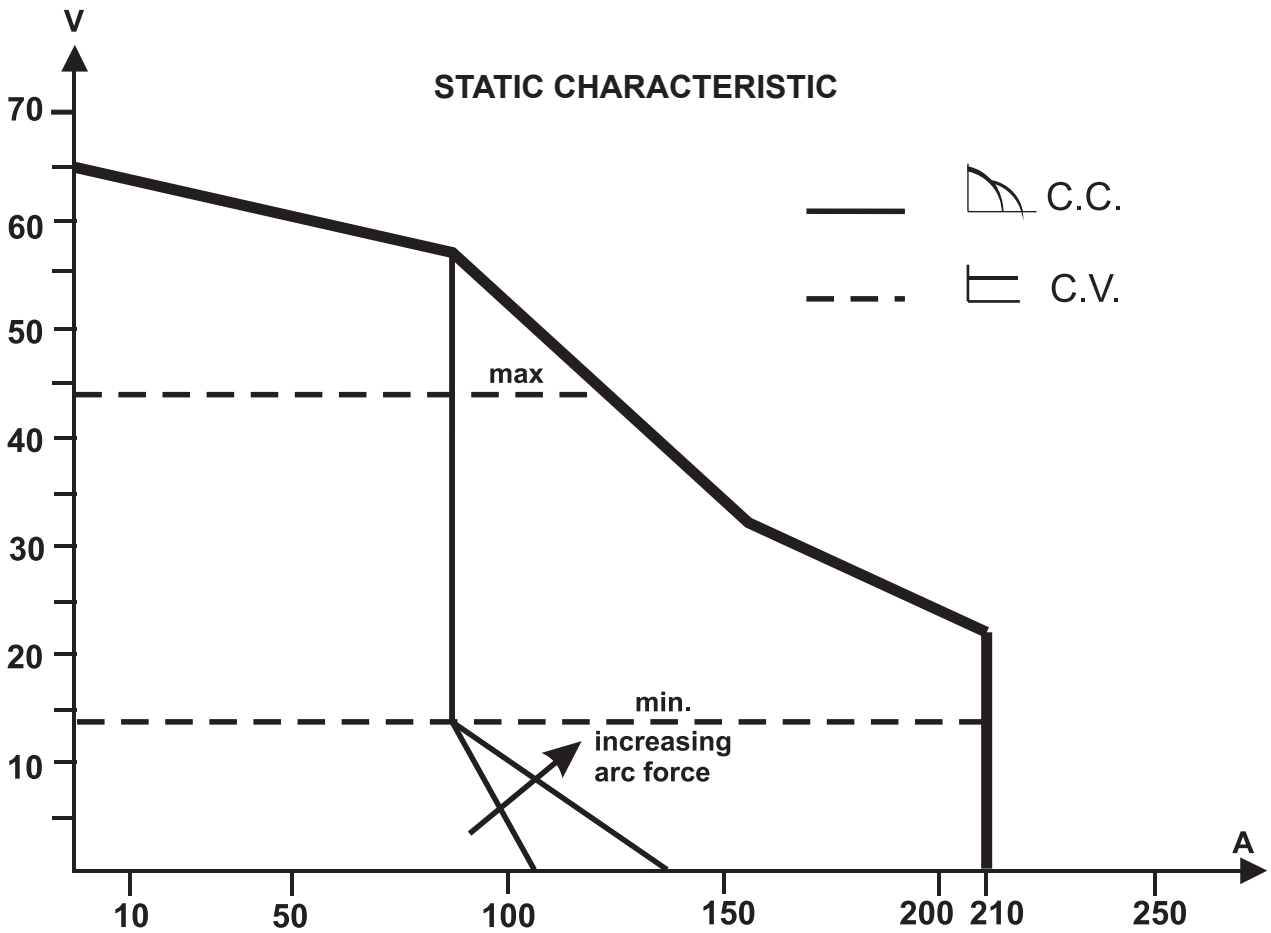

SIMULTANEOUS UTILIZATION FACTORS

In case **Welding** and **Generation** can be used simultaneously, however, the engine **cannot** be overloaded. The table below gives the maximum limits to be respected.

WELDING CURRENT	>210A	150A	100A	0
AUXILIARY POWER	0	0 kVA	2.7 kVA	6.5 kVA

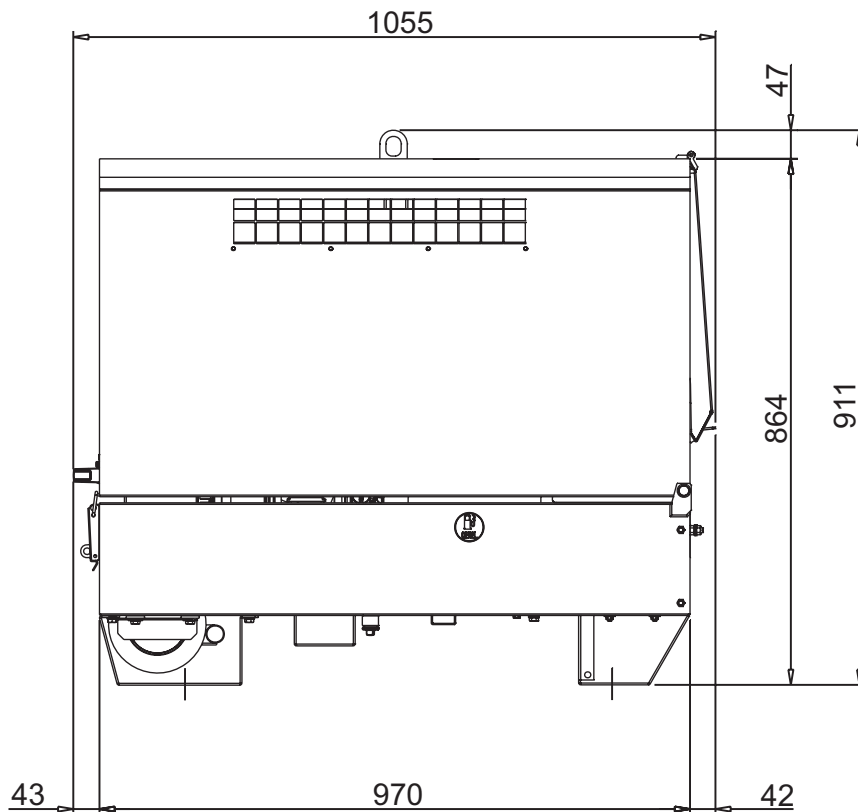
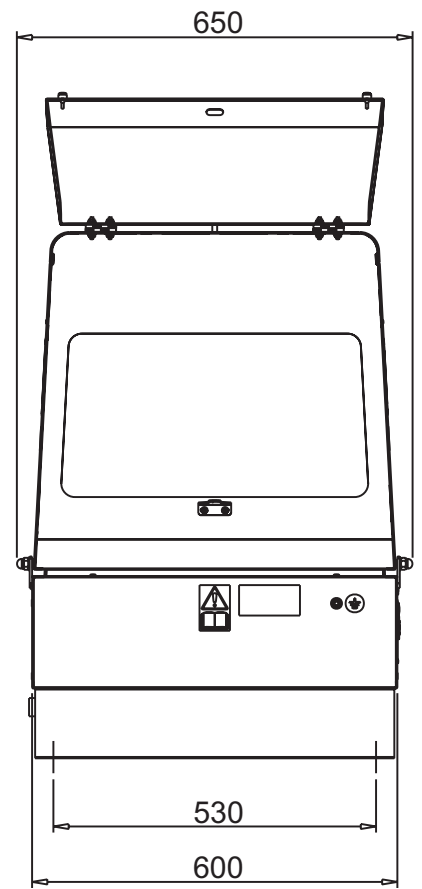
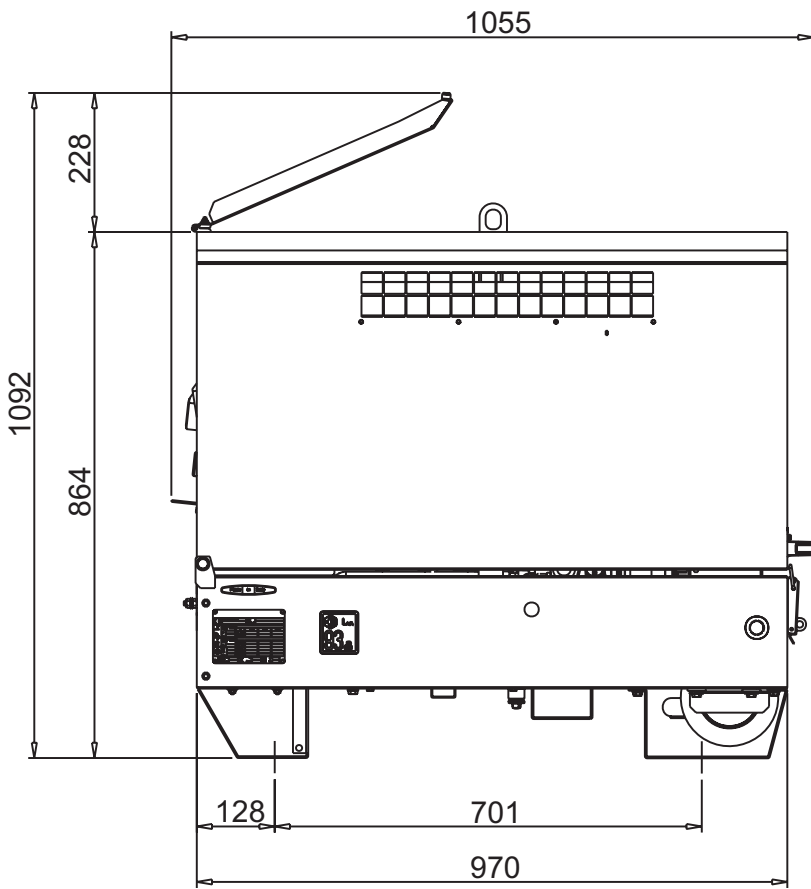

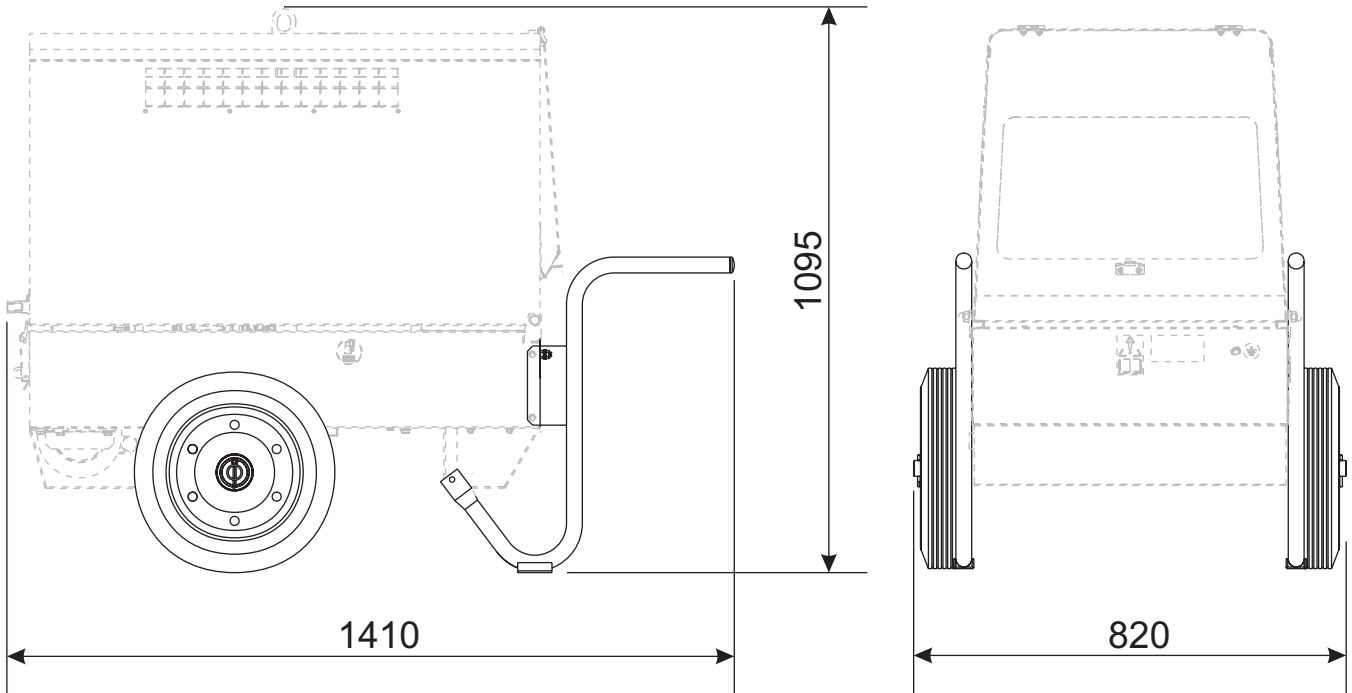

MOSA

MOSA div. della BCS S.p.A.

Viale Europa, 59 20090 Cusago (Milano) Italy

Tel. +39 - 0290352.1 Fax +39 - 0290390466 www.mosa.it

